

BLADE[®]

NANO QX2



SAFE[®] 

BNF[™]

NOTICE

All instructions, warranties and other collateral documents are subject to change at the sole discretion of Horizon Hobby, LLC. For up-to-date product literature, visit horizonhobby.com and click on the support tab for this product.

Meaning of Special Language

The following terms are used throughout the product literature to indicate various levels of potential harm when operating this product:

NOTICE: Procedures, which if not properly followed, create a possibility of physical property damage AND a little or no possibility of injury.

CAUTION: Procedures, which if not properly followed, create the probability of physical property damage AND a possibility of serious injury.

WARNING: Procedures, which if not properly followed, create the probability of property damage, collateral damage, and serious injury OR create a high probability of superficial injury.



WARNING: Read the ENTIRE instruction manual to become familiar with the features of the product before operating. Failure to operate the product correctly can result in damage to the product, personal property and cause serious injury.

This is a sophisticated hobby product. It must be operated with caution and common sense and requires some basic mechanical ability. Failure to operate this Product in a safe and responsible manner could result in injury or damage to the product or other property. This product is not intended for use by children without direct adult supervision. Do not use with incompatible components or alter this product in any way outside of the instructions provided by Horizon Hobby, LLC. This manual contains instructions for safety, operation and maintenance. It is essential to read and follow all the instructions and warnings in the manual, prior to assembly, setup or use, in order to operate correctly and avoid damage or serious injury.

Age Recommendation: Not for children under 14 years. This is not a toy.

Safety Precautions and Warnings

- Always keep a safe distance in all directions around your model to avoid collisions or injury. This model is controlled by a radio signal subject to interference from many sources outside your control. Interference can cause momentary loss of control.
- Always operate your model in open spaces away from full-size vehicles, traffic and people.
- Always carefully follow the directions and warnings for this and any optional support equipment (chargers, rechargeable battery packs, etc.).
- Always keep all chemicals, small parts and anything electrical out of the reach of children.
- Always avoid water exposure to all equipment not specifically designed and protected for this purpose. Moisture causes damage to electronics.
- Never place any portion of the model in your mouth as it could cause serious injury or even death.
- Never operate your model with low transmitter batteries.
- Always keep aircraft in sight and under control.
- Always move the throttle fully down at rotor strike.
- Always use fully charged batteries.
- Always keep transmitter powered on while aircraft is powered.
- Always remove batteries before disassembly.
- Always keep moving parts clean.
- Always keep parts dry.
- Always let parts cool after use before touching.
- Always remove batteries after use.
- Never operate aircraft with damaged wiring.
- Never touch moving parts.

If you are operating this product in North America, you are required to have an Amateur Radio (HAM) license. For information on obtaining an Amateur Radio license visit www.arrl.org.

Table of Contents

Box Contents	5	Using the Micro FPV Camera	14
First Flight Preparation	6	Post-Flight Inspection and Maintenance Checklist	15
Flying Checklist	6	Replacing the Propellers	15
Charging Warnings	6	Replacing the Motors	16
Battery Charging	7	Troubleshooting Guide	16
Transmitter Setup	8	Exploded View	18
Installing the Flight Battery	9	Parts Listings	19
Transmitter and Receiver Binding	10	Optional Parts	19
SAFE® Technology	10	Limited Warranty	19
Understanding the Primary Flight Controls	11	Warranty and Service Contact Information	21
LED Codes	12	FCC Statement	22
Flight Mode Selection	12	IC Information	22
Flying the Quadcopter	12	Compliance Information for the European Union	23

Specifications

Length	5.1 in (130mm)	Propeller Diameter	2.3 in (60mm)
Width	5.1 in (130mm)	Flying Weight	1.8 oz (52 g)
Height	1.9 in (50mm)		

To receive product updates, special offers and more, register your product at www.bladehelis.com

Box Contents

- Blade® Nano QX2 FPV Quadcopter
- 25mW Micro Camera System
- 500mAh 1S 3.7V 25C LiPo
- 1S USB Li-Po Charger, 500mAh High Current UMX Connector

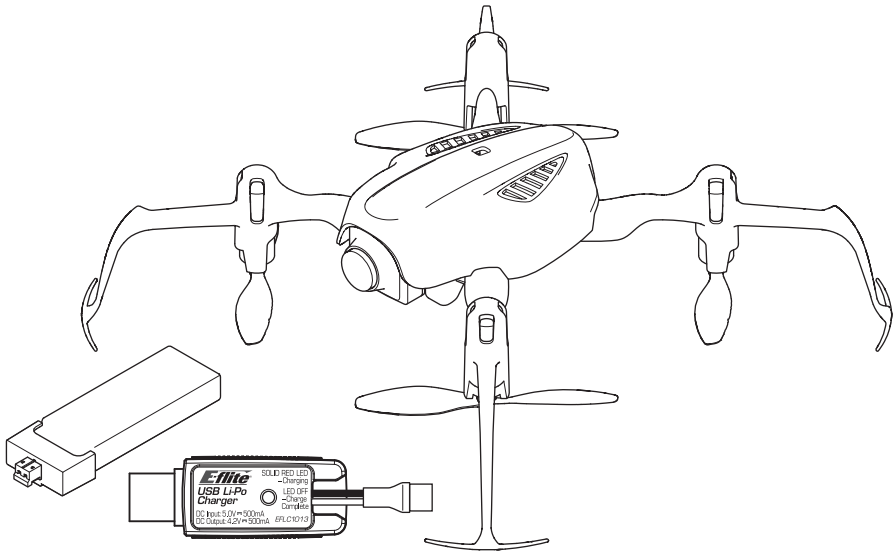

First Flight Preparation

- Remove and inspect contents
- Begin charging the flight battery
- Install the flight battery in the quadcopter (once it has been fully charged)
- Program your computer transmitter
- Bind your transmitter
- Familiarize yourself with the controls
- Find a suitable area for flying

Charging Warnings



CAUTION: All instructions and warnings must be followed exactly. Mishandling of Li-Po batteries can result in a fire, personal injury and/or property damage.

- **NEVER LEAVE CHARGING BATTERIES UNATTENDED.**
- **NEVER CHARGE BATTERIES OVERNIGHT.**
- By handling, charging or using the included Li-Po battery, you assume all risks associated with lithium batteries.
- If at any time the battery begins to balloon or swell, discontinue use immediately. If charging or discharging, discontinue and disconnect. Continuing to use, charge or discharge a battery that is ballooning or swelling can result in fire.
- Always store the battery at room temperature in a dry area for best results.
- Always transport or temporarily store the battery in a temperature range of 40–120° F (5–49° C).
- Do not store battery or model in a car or direct sunlight. If stored in a hot car, the battery can be damaged or even catch fire.

Flying Checklist

- Always turn the transmitter on first**
- Plug the flight battery into the lead from the 4-in-1 control unit
- Allow the 4-in-1 control unit to initialize and arm properly
- Fly the model
- Land the model
- Unplug the flight battery from the 4-in-1 control unit
- Always turn the transmitter off last**

- Always charge batteries away from flammable materials.
- Always inspect the battery before charging.
- Always disconnect the battery after charging, and let the charger cool between charges.
- Always constantly monitor the temperature of the battery pack while charging.
- **ONLY USE A CHARGER SPECIFICALLY DESIGNED TO CHARGE LI-PO BATTERIES.** Failure to charge the battery with a compatible charger may cause a fire resulting in personal injury and/or property damage.
- Never discharge Li-Po cells to below 3V under load.
- Never cover warning labels with hook and loop strips.
- Never charge batteries outside recommended levels.
- Never charge damaged batteries.
- Never attempt to dismantle or alter the charger.
- Never allow minors to charge battery packs.
- Never charge batteries in extremely hot or cold places (recommended between 40–120° F or (5–49° C) or place in direct sunlight.

Battery Charging



CAUTION: Only use chargers specifically designed to charge the included Li-Po battery. Failure to do so could result in fire, causing injury or property damage.



CAUTION: Never exceed the recommended charge rate.

The Battery Charger (EFLC1013) included with your quadcopter has been designed to safely charge the 1S 3.7V 500mAh Li-Po flight battery. Refer to the charging warnings. It is recommended to charge the battery pack while you are inspecting the aircraft. The flight battery will be required to confirm proper aircraft operation in future steps.

NOTICE: Inspect the battery to make sure it is not damaged e.g., swollen, bent, broken or punctured. Charge only batteries that are cool to the touch and are not damaged.

1. Insert the charger into a USB port. The charger only uses power from the USB port. USB power supplies, such as those used to charge cellular phones, can also be used.

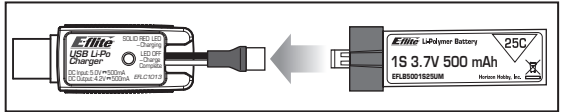

2. Connect the battery to the charger as shown in the illustration above. When you make the connection successfully, the LED on the charger turns solid red, indicating charging has begun. Charging a fully discharged (not over-discharged) 500mAh battery takes approximately 60 minutes. The LED goes out when the charge is complete.

CHARGING (Solid Red LED)

MAX CHARGE (LED OFF)

3. Always disconnect the flight battery from the charger immediately upon completion of charging.



CAUTION: Once charging is complete, immediately remove the battery. Never leave a battery connected to the charger.

Transmitter Setup

30% exponential on aileron and elevator is recommended if it is available on your chosen transmitter.

Transmitter	"Model Type"	Stability to Agility TX Setup	Stability to Agility Switch	Dual Rate Switch	High Rate	Low Rate
DX6i	Acro	In FLAPS Menu: Set NORM FLAP to Down 20	Cycle Flaps Pos first time 0-1, each time after 1-0-1	ELEV-AIL D/R	100%	70%
DX7S, DX8	Acro	In Switch Select Menu: Set Flap to Inh, Set Trainer to Aux1	Press Trainer/Bind	ELEV-AIL D/R	100%	70%
DX6, DX7 (Gen 2), DX9, DX18	Acro	In Channel Assign Menu Go to Next: Set 6 AUX1: to I	Press Trainer/Bind	ELEV-AIL D/R	100%	70%

DXe users:

Use the default model settings. Press and release the bind/panic/trainer button to cycle between the flight modes.

Installing the Flight Battery

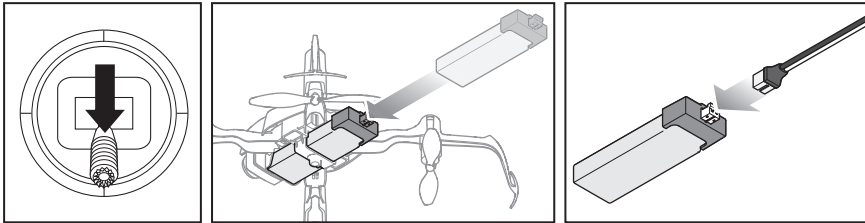

1. Lower the throttle to the lowest setting and center all trims.
2. Power ON the transmitter.
3. Insert the battery as shown.
4. Connect the battery cable to the 4-in-1 control unit.

CAUTION: Connecting the battery to the control board with reversed polarity will cause damage to the control board, the battery or both. Damage caused by incorrectly connecting the battery is not covered under warranty.

5. Place the quadcopter upright on a flat surface. Do not move the quadcopter until the LED on the 4-in-1 control unit is solid blue (not blinking). If the LED continues to rapidly flash blue, refer to the *Transmitter and Receiver Binding* section.

CAUTION: Always disconnect the Li-Po battery from the aircraft when not flying to avoid over-discharging the battery. Batteries discharged to a voltage lower than the lowest approved voltage may become damaged, resulting in loss of performance and potential fire when the batteries are charged.

Transmitter and Receiver Binding

To bind or re-bind your aircraft to your chosen transmitter, please follow the directions below.

General Binding Procedure

1. Disconnect the flight battery from the quadcopter.
2. Center all trims on your transmitter.
3. Power off the transmitter and fully lower the throttle.
4. Connect the flight battery in the quadcopter. The blue LED on the 4-in-1 control unit flashes rapidly, indicating it is in bind mode.
5. Put the transmitter into bind mode while powering on the transmitter.
6. Release the bind button/switch after 2–3 seconds. The quadcopter is bound when the blue LED on the 4-in-1 control unit turns solid.
7. Disconnect the flight battery and power the transmitter off.

If you encounter problems, obey binding instructions and refer to the troubleshooting guide for other instructions. If needed, contact the appropriate Horizon Product Support office. For a list of compatible DSM® transmitters, please visit www.bindnfly.com.

SAFE Technology

Revolutionary SAFE® (Sensor Assisted Flight Envelope) technology uses an innovative combination of multi-axis sensors and software that allows model aircraft to know its position relative to the horizon. This spatial awareness is utilized to create a controlled flight envelope the aircraft uses to maintain a safe region of bank and pitch angles so you can fly more safely. Far beyond stability, this level of protection offers multiple modes so the pilot can choose to develop his or her skills with a greater degree of security and flight control that always feels crisp and responsive.

SAFE technology delivers:

- Flight envelope protection you can enable at the flip of a switch.
- Multiple modes to let you adapt SAFE technology to your skill level instantly.

Best of all, sophisticated SAFE technology doesn't require any work to enjoy. Every aircraft with SAFE technology is ready to use and optimized to offer the best possible flight experience.

FlySAFERC.com

Understanding the Primary Flight Controls

If you are not familiar with the controls of your Nano QX2 FPV quadcopter, take a few minutes to familiarize yourself with them before attempting your first flight.

Throttle

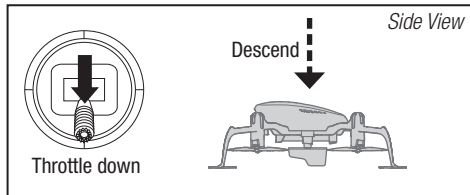
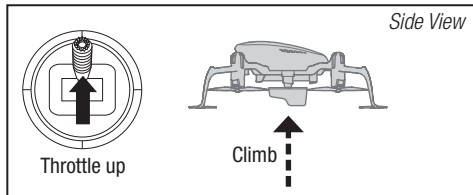

Rudder

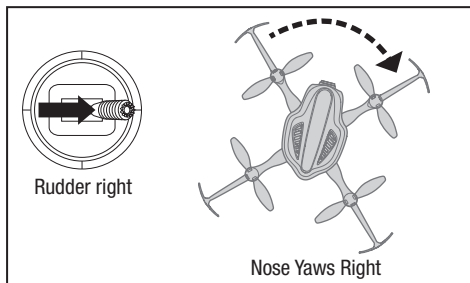
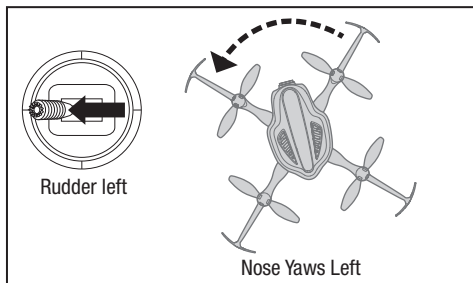

Elevator

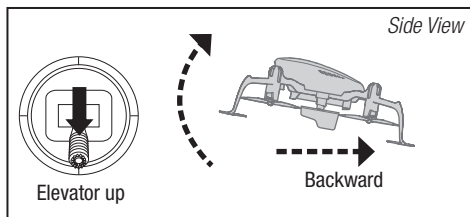
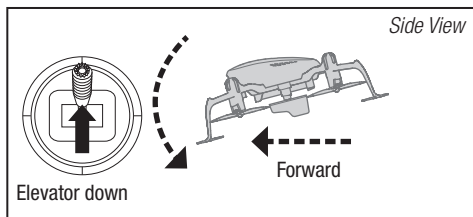

Aileron

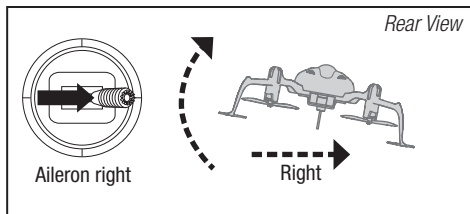
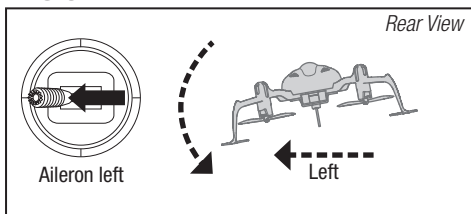

LED Codes

Equipment	LED Color	LED Status	Operation
Quadcopter	Off	Off	Loss of transmitter signal
	Blue	Rapid Blink	Bind Mode
		Solid	Stability Mode
	Red	Solid	Agility Mode
Blink		Low Battery	

Flight Mode Selection

Refer to the *Transmitter Setup* section for transmitter switch selection and specific setup information.

- **Stability mode** (quadcopter LED blue): the bank angle is limited. When the sticks are released, the quadcopter will return to level flight.
- **Agility mode** (quadcopter LED red): the quadcopter has no bank angle limits and will not return to level flight if the sticks are released. Use rates and expo to tune the performance according to your flying style.

Flying the Quadcopter

Consult your local laws and ordinances before choosing a location to fly your aircraft.

We recommend flying your aircraft outside in calm winds (less than 5 mph) or inside a large gymnasium. Always avoid flying near houses, trees, wires and buildings. You should also be careful to avoid flying in areas where there are many people, such as busy parks, schoolyards or soccer fields.

Takeoff

Increase the throttle until the model is approximately 2 ft. (600mm) off the ground in a low-level hover and concentrate on balancing the throttle stick's position so that the quadcopter holds a steady hover altitude. In some cases, you may need to make a few short "hops" to an altitude of just a few inches until you become familiar with the control inputs and trim settings required to maintain a steady hover and altitude.

Hovering

The Nano QX2 FPV quadcopter requires minor throttle adjustments to maintain its altitude in hover. Remember to keep these throttle adjustments as minimal as possible. Large adjustments could result in a loss of control and/or a possible crash.

While attempting to establish a low-level hover, check to see if any trim adjustments are required to help keep the quadcopter from constantly drifting in various directions. If you find that it constantly drifts without any directional control input, land the model before making any adjustments to the trim settings.

- If the nose of the quadcopter rotates to the left or right, adjust the rudder trim.
- If the quadcopter continually drifts forward or backward, adjust the elevator trim.
- If the quadcopter continually drifts to the left or right, adjust the aileron trim.

Continue making minor trim adjustments until the machine hovers at a low altitude with very little drifting and directional control input. If this is your first multicopter or helicopter, seek the help of an experienced pilot to trim the model for you before making your first flight.

With your quadcopter properly trimmed and maintaining a stable low-level hover, practice using the rudder, elevator and aileron controls to familiarize yourself with the machine's responses to control inputs. Remember to keep the control inputs as minimal as possible.

NOTICE: Crash damage is not covered under warranty.

Low Voltage Cutoff (LVC)

Once the battery reaches 3V under load, the ESC will continuously lower power supplied to the motor until complete shutdown occurs. This helps prevent over-discharge of the Li-Po battery. Land immediately once the ESC activates LVC. Continuing to fly after LVC can damage the battery, cause a crash, or both. Crash damage and batteries damaged due to over-discharge are not covered under warranty.

NOTICE: Repeated flying to LVC will damage the battery.

Flight time with a fully charged battery is approximately 3-5 minutes, depending on how aggressively the quadcopter is flown.

LVC does not prevent the battery from over-discharge during storage.

Landing

To land, slowly decrease the throttle while in a low-level hover. After landing, lower the throttle completely to stop the motors. Disconnect and remove the battery from the quadcopter to prevent over discharge. During storage, make sure the battery charge does not fall below 3V per cell.

Using the Micro FPV Camera

Consult local laws and ordinances before operating FPV equipment. In some areas, FPV operation may be limited or prohibited. You are responsible for operating this product in a legal and responsible manner.

1. Power on your radio transmitter, then power on the aircraft.
2. Power on the video receiver to make sure the channel is clear.
3. Select the desired video transmitter channel by pressing the button on the quadcopter to scroll through the available channels, 1-7, as shown.
4. Adjust the vertical camera angle by rotating the camera up or down prior to flight.
5. Perform a range test before flying.

If you experience static in the video feed, select a different channel.

NOTICE: The 25mW micro video camera range on your quadcopter is less than your flight control transmitter range. Ensure you have adequate video camera range for filming.

Tip: If you are flying with an FPV headset and are prone to motion sickness, sit in a chair. If you start to suffer from motion sickness while flying, lower your chin against your chest.

Fly in open areas, away from people, trees, cars, and buildings. The range of the system can be impacted by any obstructions blocking your signal. It is normal to see break up in the video going behind trees and other obstacles.

Avoid flying in the same general area as 5.8 GHz WiFi sources as this may seriously degrade the range of the FPV system.

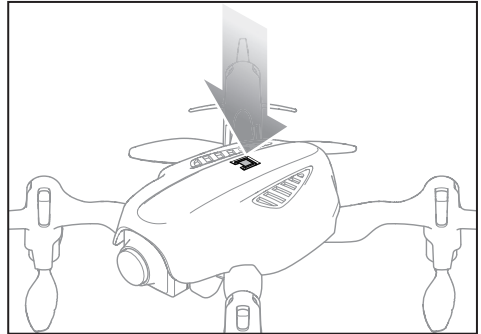

Ultra Micro FPV Camera Transmitter Channels

Channel 1	5740 MHz
Channel 2	5760 MHz
Channel 3	5780 MHz
Channel 4	5800 MHz
Channel 5	5820 MHz
Channel 6	5840 MHz
Channel 7	5860 MHz

These frequencies are compatible with Band F, Fatshark, Immersion RC and Airwave video receiver products

Post-Flight Inspection and Maintenance Checklist

✓		
Cleaning	Make sure the battery is not connected before cleaning. Remove dust and debris with a soft brush or a dry, lint-free cloth.	
Motors	Replace the motor when the model will not fly steady or veers off when doing a climb out.	
Wiring	Make sure the wiring does not block moving parts. Replace damaged wiring and loose connectors.	
Fasteners	Make sure there are no loose screws, other fasteners or connectors. Do not over-tighten metal screws in plastic parts. Tighten screws so the parts are mated together, then turn screw only 1/8th of a turn more.	
Propellers	Make sure there is no damage to the propellers or other parts that move at high speed. Damage to these parts includes cracks, burrs, chips or scratches. Replace damaged parts before flying.	

Replacing the Propellers

Use the directions below to replace any propeller that becomes damaged:

1. Check tip angle of the propeller blades as shown.
2. Refer to the propeller rotation diagram to determine which propeller should be used.
3. Pull the damaged propeller off the motor shaft.
4. Slide the appropriate new propeller onto the motor shaft.

If the quadcopter crashes immediately upon increasing the throttle, confirm the propellers are located correctly.

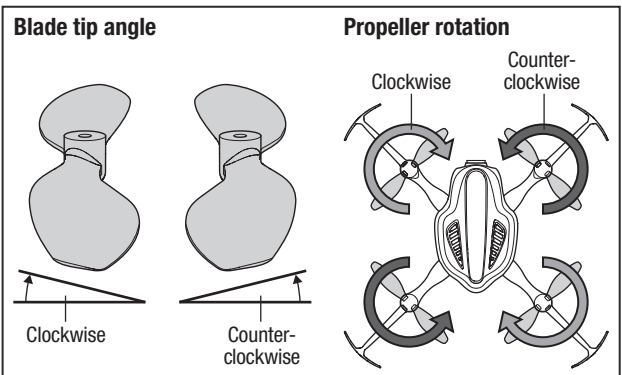

Replacing the Motors

The motor rotation direction can be determined by the color of the wire leads. The clockwise motors have black and white leads. The counter-clockwise motors have red and blue leads.

1. Refer to the propeller rotation diagram in the Replacing the Propellers section. Determine which motor needs to be replaced and which direction it rotates.
2. Unplug the motor wire from the 4-in-1 board.
3. Using your thumbs, carefully spread the base of the motor pod apart while pushing the motor downward out of the pod as shown.
4. Slide the new motor into the pod until it is captured by the bottom of the motor pod.
5. Route the wire lead through the arm of the frame and plug the connector into the 4-in-1 board. Make sure to clip the wire into the frame arm to keep the wire from interfering with the spinning propeller.

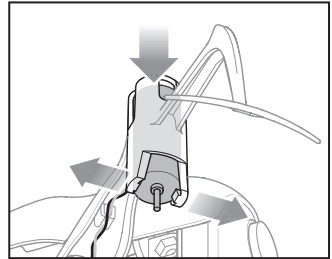
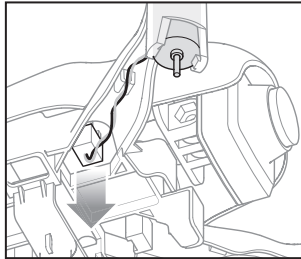

Troubleshooting Guide

Problem	Possible Cause	Solution
Control response is inconsistent or requires extra trim to neutralize movement	Aircraft not initialized on a level surface	Disconnect the flight battery, center the control trim and re-initialize the quadcopter
	Battery not correctly placed in battery slot	Adjust battery position so quadcopter balances in the center of the frame
Will not respond to throttle	Throttle too high and/or throttle trim is too high	Reset controls with the throttle stick and throttle trim at the lowest setting
	Quadcopter moved during initialization	Disconnect the flight battery and re-initialize the quadcopter while keeping it from moving
	Throttle channel is reversed	Disconnect flight battery, reverse the throttle channel on the transmitter, reconnect flight battery
Does not function and smells burnt after connecting the flight battery	Flight battery connected with the wrong polarity	Replace the 4-in-1 board. Connect the flight battery noting proper polarity

Problem	Possible Cause	Solution
Reduced flight time or is underpowered	Flight battery charge is low	Completely recharge the flight battery
	Inadequate power to flight battery charger	Use a different USB power source for the charger
	Flight battery is damaged	Replace the flight battery and follow the flight battery instructions
	Flight conditions might be too cold	Make sure the battery is warm (room temperature) before use
	One or more propellers are fouled	Clean any pet hair, lint or grass away from the base of the propellers
LED on receiver flashes rapidly and quadcopter will not respond to transmitter (during binding)	Transmitter too near aircraft during binding process	Power off the transmitter. Move the transmitter a larger distance from the aircraft. Disconnect and reconnect the flight battery to the aircraft. Follow the binding instructions
	Bind switch or button was not held while transmitter was powered on	Power off transmitter and repeat bind process
	Aircraft or transmitter is too close to large metal object, wireless source or another transmitter	Move aircraft and transmitter to another location and attempt binding again
LED on the receiver flashes rapidly and the quadcopter will not respond to the transmitter (after binding)	Less than a 5-second wait between first powering on the transmitter and connecting the flight battery to the quadcopter	Leave the transmitter powered on. Disconnect and reconnect the flight battery to the quadcopter
	The quadcopter is bound to a different model memory (ModelMatch™ transmitters only)	Select the correct model memory on the transmitter. Disconnect and reconnect the flight battery to the quadcopter
	Flight battery or transmitter battery charge is too low	Replace or recharge batteries
	Aircraft or transmitter is too close to large metal object, wireless source or another transmitter	Move aircraft and transmitter to another location and attempt connecting again
Crashes immediately upon lift-off	Propellers in wrong locations or incorrect flight mode selected	Make necessary adjustments
Static in FPV feed	Interference on chosen channel	Change the video transmitter and receiver channel per the Using the Micro Camera section
	Flying too close to 5.8 GHz WiFi source	Remove WiFi source or move to a different flying area

Exploded View

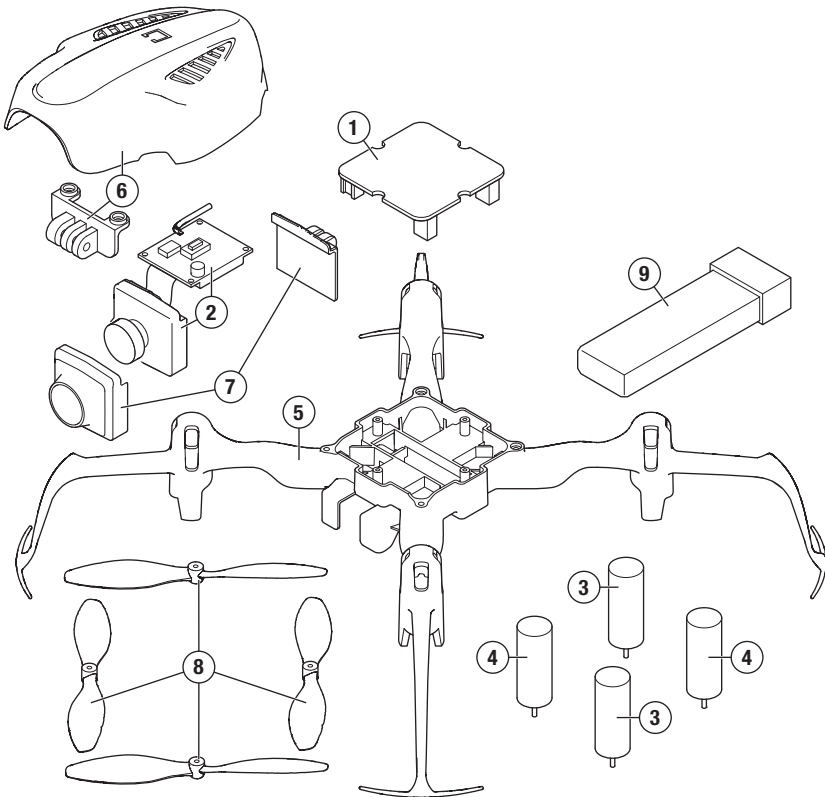

Parts Listings

Part #	Description
1	BLH9103 4-in-1 Control Unit
2	BLH9011 Camera Board
3	BLH2204 Clockwise Motor
4	BLH2205 Counter-Clockwise Motor
5	BLH2207 Main Frame
6	BLH9101 Canopy Body

Part #	Description
7	BLH9007 Camera Mount
8	BLH9102 Prop Set
9	EFLB5001S25UM 500mAh 1S 3.7V 25C LiPo, High Current UMX Connector
	EFLC1013 1S USB Li-Po Charger, 500mAh High Current UMX

Optional Parts

Part #	Description
SPMVR2500	Focal™ FPV Wireless Headset
SMVR1100	Teleporter V4 Video Headset with Head Tracking
	DXe DSMX Transmitter Only
	DX7s DSMX 7-Channel Transmitter Only
	DX6 DSMX 6-Channel Transmitter Only

Part #	Description
	DX7 DSMX 7-Channel Transmitter Only
	DX8 DSMX 8-Channel Transmitter Only
	DX9 DSMX 9-Channel Transmitter Only
	DX18 DSMX 18-Channel Transmitter Only

Limited Warranty

What this Warranty Covers

Horizon Hobby, LLC, (Horizon) warrants to the original purchaser that the product purchased (the "Product") will be free from defects in materials and workmanship at the date of purchase.

What is Not Covered

This warranty is not transferable and does not cover (i) cosmetic damage, (ii) damage due to acts of God, accident, misuse, abuse, negligence, commercial use, or due to improper use, installation, operation or maintenance, (iii) modification of or to any part of the Product, (iv) attempted service by anyone other than a Horizon Hobby authorized service center, (v) Product not

purchased from an authorized Horizon dealer, (vi) Product not compliant with applicable technical regulations, or (vii) use that violates any applicable laws, rules, or regulations.

OTHER THAN THE EXPRESS WARRANTY ABOVE, HORIZON MAKES NO OTHER WARRANTY OR REPRESENTATION, AND HEREBY DISCLAIMS ANY AND ALL IMPLIED WARRANTIES, INCLUDING, WITHOUT LIMITATION, THE IMPLIED WARRANTIES OF NON-INFRINGEMENT, MERCHANTABILITY AND FITNESS FOR A PARTICULAR PURPOSE. THE PURCHASER ACKNOWLEDGES THAT THEY ALONE HAVE DETERMINED THAT THE PRODUCT WILL SUITABLY MEET THE REQUIREMENTS OF THE PURCHASER'S INTENDED USE.

Purchaser's Remedy

Horizon's sole obligation and purchaser's sole and exclusive remedy shall be that Horizon will, at its option, either (i) service, or (ii) replace, any Product determined by Horizon to be defective. Horizon reserves the right to inspect any and all Product(s) involved in a warranty claim. Service or replacement decisions are at the sole discretion of Horizon. Proof of purchase is required for all warranty claims. SERVICE OR REPLACEMENT AS PROVIDED UNDER THIS WARRANTY IS THE PURCHASER'S SOLE AND EXCLUSIVE REMEDY.

Limitation of Liability

HORIZON SHALL NOT BE LIABLE FOR SPECIAL, INDIRECT, INCIDENTAL OR CONSEQUENTIAL DAMAGES, LOSS OF PROFITS OR PRODUCTION OR COMMERCIAL LOSS IN ANY WAY, REGARDLESS OF WHETHER SUCH CLAIM IS BASED IN CONTRACT, WARRANTY, TORT, NEGLIGENCE, STRICT LIABILITY OR ANY OTHER THEORY OF LIABILITY, EVEN IF HORIZON HAS BEEN ADVISED OF THE POSSIBILITY OF SUCH DAMAGES.

Further, in no event shall the liability of Horizon exceed the individual price of the Product on which liability is asserted. As Horizon has no control over use, setup, final assembly, modification or misuse, no liability shall be assumed nor accepted for any resulting damage or injury. By the act of use, setup or assembly, the user accepts all resulting liability. If you as the purchaser or user are not prepared to accept the liability associated with the use of the Product, purchaser is advised to return the Product immediately in new and unused condition to the place of purchase.

Law

These terms are governed by Illinois law (without regard to conflict of law principals). This warranty gives you specific legal rights, and you may also have other rights which vary from state to state. Horizon reserves the right to change or modify this warranty at any time without notice.

WARRANTY SERVICES

Questions, Assistance, and Services

Your local hobby store and/or place of purchase cannot provide warranty support or service. Once assembly, setup or use of the Product has been started, you must contact your local distributor or Horizon directly. This will enable Horizon to better

answer your questions and service you in the event that you may need any assistance. For questions or assistance, please visit our website at www.horizonhobby.com, submit a Product Support Inquiry, or call the toll free telephone number referenced in the Warranty and Service Contact Information section to speak with a Product Support representative.

Inspection or Services

If this Product needs to be inspected or serviced and is compliant in the country you live and use the Product in, please use the Horizon Online Service Request submission process found on our website or call Horizon to obtain a Return Merchandise Authorization (RMA) number. Pack the Product securely using a shipping carton. Please note that original boxes may be included, but are not designed to withstand the rigors of shipping without additional protection. Ship via a carrier that provides tracking and insurance for lost or damaged parcels, as Horizon is not responsible for merchandise until it arrives and is accepted at our facility. An Online Service Request is available at http://www.horizonhobby.com/content/_service-center_render-service-center. If you do not have internet access, please contact Horizon Product Support to obtain a RMA number along with instructions for submitting your product for service. When calling Horizon, you will be asked to provide your complete name, street address, email address and phone number where you can be reached during business hours. When sending product into Horizon, please include your RMA number, a list of the included items, and a brief summary of the problem. A copy of your original sales receipt must be included for warranty consideration. Be sure your name, address, and RMA number are clearly written on the outside of the shipping carton.

NOTICE: Do not ship Li-Po batteries to Horizon. If you have any issue with a Li-Po battery, please contact the appropriate Horizon Product Support office.

Warranty Requirements

For Warranty consideration, you must include your original sales receipt verifying the proof-of-purchase date.

Provided warranty conditions have been met, your Product will be serviced or replaced free of charge. Service or replacement decisions are at the sole discretion of Horizon.

Non-Warranty Service

Should your service not be covered by warranty, service will be completed and payment will be required without notification or estimate of the expense unless the expense exceeds 50% of the retail purchase cost.

By submitting the item for service you are agreeing to payment of the service without notification. Service estimates are available upon request. You must include this request with your item submitted for service. Non-warranty service estimates will be billed a minimum of ½ hour of labor. In addition you will be billed for return freight. Horizon accepts money orders and cashier's checks, as well as Visa, MasterCard, American Express, and Discover cards. By submitting any item to Horizon

for service, you are agreeing to Horizon's Terms and Conditions found on our website http://www.horizonhobby.com/content/_service-center_render-service-center.

ATTENTION: Horizon service is limited to Product compliant in the country of use and ownership. If received, a non-compliant Product will not be serviced. Further, the sender will be responsible for arranging return shipment of the un-serviced Product, through a carrier of the sender's choice and at the sender's expense. Horizon will hold non-compliant Product for a period of 60 days from notification, after which it will be discarded.

10/15

Warranty and Service Contact Information

Country of Purchase	Horizon Hobby	Contact Information	Address
United States of America	Horizon Service Center (Repairs and Repair Requests)	servicecenter.horizonhobby.com/ RequestForm/	4105 Fieldstone Rd Champaign, Illinois, 61822 USA
	Horizon Product Support (Product Technical Assistance)	productsupport@horizonhobby.com 877-504-0233	
	Sales	websales@horizonhobby.com 800-338-4639	
United Kingdom	Service/Parts/Sales: Horizon Hobby Limited	sales@horizonhobby.co.uk	Units 1-4 , Ployters Rd, Staple Tye Harlow, Essex, CM18 7NS, United Kingdom
		+44 (0) 1279 641 097	
Germany	Horizon Technischer Service Sales: Horizon Hobby GmbH	service@horizonhobby.de	Christian-Junge-Straße 1 25337 Elmshorn, Germany
		+49 (0) 4121 2655 100	
France	Service/Parts/Sales: Horizon Hobby SAS	infofrance@horizonhobby.com	11 Rue Georges Charpak 77127 Lieusaint, France
		+33 (0) 1 60 18 34 90	

FCC Statement

This equipment has been tested and found to comply with the limits for Part 15 of the FCC rules. These limits are designed to provide reasonable protection against harmful interference in a residential installation. This equipment generates uses and can radiate radio frequency energy and, if not installed and used in accordance with the instructions, may cause harmful interference to radio communications.

However, there is no guarantee that interference will not occur in a particular installation. If this equipment does cause harmful interference to radio or television reception, which can be determined by turning the equipment off and on, the user is encouraged to try to correct the interference by one or more of the following measures:

- Reorient or relocate the receiving antenna.
- Increase the separation between the equipment and receiver.
- Connect the equipment to an outlet on a circuit different from that to which the receiver is connected.

This device complies with part 15 of the FCC rules.

Operation is subject to the following two conditions: (1) This device may not cause harmful interference, and (2) this device must accept any interference received, including interference that may cause undesired operation.

NOTICE: Modifications to this product will void the user's authority to operate this equipment.

IC Information

This device complies with Industry Canada licence-exempt RSS standard(s). Operation is subject to the following two conditions: (1) this device may not cause interference, and

(2) this device must accept any interference, including interference that may cause undesired operation of the device.”

Compliance Information for the European Union

EU Compliance Statement:

Horizon Hobby, LLC hereby declares that this product is in compliance with the essential requirements and other relevant provisions of the R&TTE and EMC Directives.

A copy of the EU Declaration of Conformity is available online at:
<http://www.horizonhobby.com/content/support-render-compliance>.

Instructions for disposal of WEEE by users in the European Union



This product must not be disposed of with other waste. Instead, it is the user's responsibility to dispose of their waste equipment by handing it over to a designated collections point for the recycling of waste electrical and electronic equipment. The separate collection and recycling of your waste equipment at the time of disposal will help to conserve natural resources and make sure that it is recycled in a manner that protects human health and the environment. For more information about where you can drop off your waste equipment for recycling, please contact your local city office, your household waste disposal service or where you purchased the product.



E328

©2016 Horizon Hobby, LLC.

Blade, E-flite, SAFE, the SAFE logo, DSM2, DSMX, Bind-N-Fly, the BNF logo, ModelMatch and the Horizon Hobby logo are trademarks or registered trademarks of Horizon Hobby, LLC. The Spektrum trademark is used with permission of Bachmann Industries, Inc. Futaba is a registered trademark of Futaba Denshi Kogyo Kabushiki Kaisha Corporation of Japan. All other trademarks, service marks or logos are property of their respective owners. Patents pending.

Created 02/16

51184

BLH9180