

PRO BOAT™

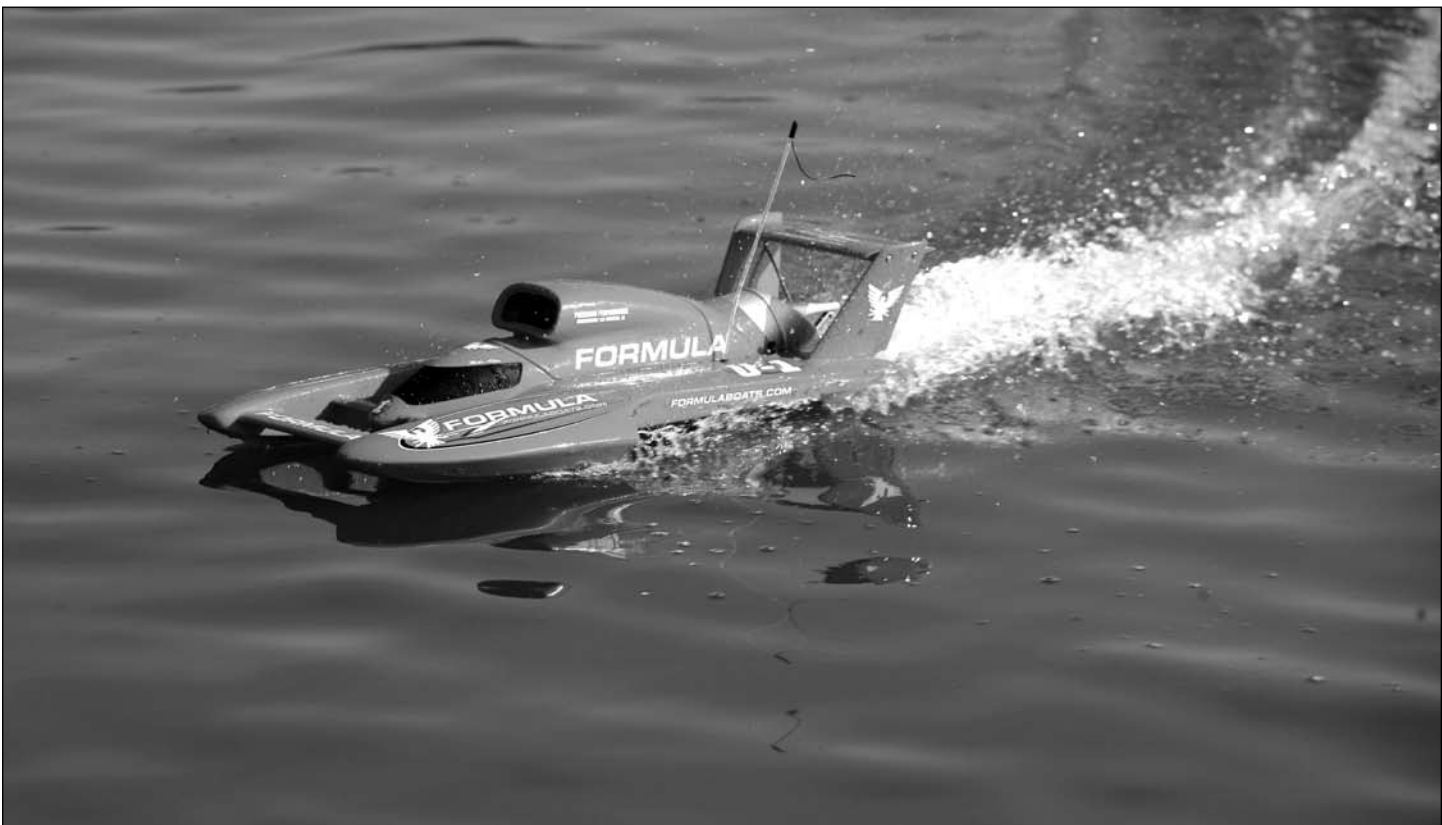

1/12-Scale Formula Hydro Unlimited Hydroplane Owner's Manual



Specifications

Length..... 27.5 in (698.5mm)
Beam 14 in (355.6mm)
Engine..... DYN .18 Marine with Tiger Drive
Radio System..... Pro Boat™ 27MHz AM Radio System

Officially Licensed replica
of the 2006 ABRA High
Points Champion.

Table of Contents

Limited Warranty & Limits of Liability	3
Additional Required Items	5
Suggested Field Equipment and Supplies	5
Contents	5
Section 1: Installing the Receiver and Transmitter Batteries	6
Section 2: Turn Fin.....	8
Section 3: Filling the Fuel Tank	9
Section 4: Range Checking the Pro Boat Radio System	9
Section 5: Starting the Dynamite .18 Engine	10
Section 6: Maintenance	12
Section 7: Troubleshooting Guide	14
Appendix.....	14
Section 8: Formula Hydro Replacement Parts.....	15

Introduction

Congratulations on the purchase of your Pro Boat™ 1/12 Formula Hydro Unlimited Hydroplane. You are just minutes from one of the most thrilling experiences that the radio control hobby has to offer.

The Pro Boat Formula Hydro is a professionally built, ready-to-run 1/12-scale fiberglass model of one of the most competitive race boats on the Unlimited Hydroplane tour. Powered by the potent Dynamite® .18 marine engine, you will be able to race across the water at speeds in excess of 30 mph!

Read this owner's manual thoroughly. You also need to read the included Dynamite .18 engine manual, along with the Pro Boat pistol-grip radio system manual.

It is very important that you operate this boat responsibly. With proper care and maintenance, you will be able to enjoy your Formula Hydro for many years to come.

Carefully unpack Formula Hydro and examine the boat and its contents. The contents contain the Formula Hydro RTR with radio installed, a boat stand, hand-held starter, and the Pro Boat pistol-grip radio transmitter. If you are missing any of these items or notice any damage, immediately contact the place of purchase.

General Guidelines

It is important that you read and follow this instruction manual, along with the Pro Boat radio system manual and the Dynamite .18 engine manual, before you run this exciting boat. Failure to read and understand the manual could result in personal injury, property damage or permanent damage to your boat! It is also important to run your boat responsibly. With proper care and maintenance, you will be able to proudly enjoy your Formula Hydro for many years to come.

This boat has been designed to race in a clockwise oval path, just like its full scale counterpart. At high speeds do not attempt turns to the left, as the boat may become unstable. If you have to turn left, do so in a large diameter turn and at slow speeds.

When operating the boat, stay clear of people, full-scale boats, stationary objects and wildlife. It is preferable to operate the Formula Hydro in low wake, low wind conditions and in areas free of people, wildlife and objects.

Before you operate your model, make sure that your radio frequency is clear. If someone is operating on the same frequency, both models could go out of control, possibly causing damage to the models or to others. Check all of the hardware, manifold, pipe and propeller for security before and after each run.

If at any time while operating your model you sense any abnormal function, end your operation immediately. Do not operate your boat again until you are certain the problem has been corrected. **Always stay clear of the propeller.**

Limited Warranty & Limits of Liability

Warranty Period

Exclusive Warranty- Horizon Hobby, Inc., (Horizon) warrants that the Products purchased (the "Product") will be free from defects in materials and workmanship at the date of purchase by the Purchaser.

Limited Warranty

(a) This warranty is limited to the original Purchaser ("Purchaser") and is not transferable. REPAIR OR REPLACEMENT AS PROVIDED UNDER THIS WARRANTY IS THE EXCLUSIVE REMEDY OF THE PURCHASER. This warranty covers only those Products purchased from an authorized Horizon dealer. Third party transactions are not covered by this warranty. Proof of purchase is required for warranty claims. Further, Horizon reserves the right to change or modify this warranty without notice and disclaims all other warranties, express or implied.

(b) Limitations- HORIZON MAKES NO WARRANTY OR REPRESENTATION, EXPRESS OR IMPLIED, ABOUT NON-INFRINGEMENT, MERCHANTABILITY OR FITNESS FOR A PARTICULAR PURPOSE OF THE PRODUCT. THE PURCHASER ACKNOWLEDGES THAT THEY ALONE HAVE DETERMINED THAT THE PRODUCT WILL SUITABLY MEET THE REQUIREMENTS OF THE PURCHASER'S INTENDED USE.

(c) Purchaser Remedy- Horizon's sole obligation hereunder shall be that Horizon will, at its option, (i) repair or (ii) replace, any Product determined by Horizon to be defective. In the event of a defect, these are the Purchaser's exclusive remedies. Horizon reserves the right to inspect any and all equipment involved in a warranty claim. Repair or replacement decisions are at the sole discretion of Horizon. This warranty does not cover cosmetic damage or damage due to acts of God, accident, misuse, abuse, negligence, commercial use, or modification of or to any part of the Product. This warranty does not cover damage due to improper installation, operation, maintenance, or attempted repair by anyone other than Horizon. Return of any goods by Purchaser must be approved in writing by Horizon before shipment.

Damage Limits

HORIZON SHALL NOT BE LIABLE FOR SPECIAL, INDIRECT OR CONSEQUENTIAL DAMAGES, LOSS OF PROFITS OR PRODUCTION OR COMMERCIAL LOSS IN ANY WAY CONNECTED WITH THE PRODUCT, WHETHER SUCH CLAIM IS BASED IN CONTRACT, WARRANTY, NEGLIGENCE, OR STRICT LIABILITY. Further, in no event shall the liability of Horizon exceed the individual price of the Product on which liability is asserted. As Horizon has no control over use, setup, final assembly, modification or misuse, no liability shall be assumed nor accepted for any resulting damage or injury. By the act of use, setup or assembly, the user accepts all resulting liability.

If you as the Purchaser or user are not prepared to accept the liability associated with the use of this Product, you are advised to return this Product immediately in new and unused condition to the place of purchase.

Law: These Terms are governed by Illinois law (without regard to conflict of law principals).

Safety Precautions

This is a sophisticated hobby Product and not a toy. It must be operated with caution and common sense and requires some basic mechanical ability. Failure to operate this Product in a safe and responsible manner could result in injury or damage to the Product or other property. This Product is not intended for use by children without direct adult supervision. The Product manual contains instructions for safety, operation and maintenance. It is essential to read and follow all the instructions and warnings in the manual, prior to assembly, setup or use, in order to operate correctly and avoid damage or injury.

Questions, Assistance, and Repairs

Your local hobby store and/or place of purchase cannot provide warranty support or repair. Once assembly, setup or use of the Product has been started, you must contact Horizon directly. This will enable Horizon to better answer your questions and service you in the event that you may need any assistance. For questions or assistance, please direct your email to productsupport@horizonhobby.com, or call 877.504.0233 toll free to speak to a service technician.

Inspection or Repairs

If this Product needs to be inspected or repaired, please call for a Return Merchandise Authorization (RMA). Pack the Product securely using a shipping carton. Please note that original boxes may be included, but are not designed to withstand the rigors of shipping without additional protection. Ship via a carrier that provides tracking and insurance for lost or damaged parcels, as **Horizon is not responsible for merchandise until it arrives and is accepted at our facility.** A Service Repair Request is available at www.horizonhobby.com on the "Support" tab. If you do not have internet access, please include a letter with your complete name, street address, email address and phone number where you can be reached during business days, your RMA number, a list of the included items, method of payment for any non-warranty expenses and a brief summary of the problem. Your original sales receipt must also be included for warranty consideration. Be sure your name, address, and RMA number are clearly written on the outside of the shipping carton.

Limited Warranty & Limits of Liability (cont)

Warranty Inspection and Repairs

To receive warranty service, you must include your **original sales receipt** verifying the proof-of-purchase date. Provided warranty conditions have been met, your Product will be repaired or replaced free of charge. Repair or replacement decisions are at the sole discretion of Horizon Hobby.

Non-Warranty Repairs

Should your repair not be covered by warranty the repair will be completed and payment will be required without notification or estimate of the expense unless the expense exceeds 50% of the retail purchase cost. By submitting the item for repair you are agreeing to payment of the repair without notification. Repair estimates are available upon request. You must include this request with your repair. Non-warranty repair estimates will be billed a minimum of ½ hour of labor. In addition you will be billed for return freight. Please advise us of your preferred method of payment. Horizon accepts money orders and cashiers checks, as well as Visa, MasterCard, American Express, and Discover cards. If you choose to pay by credit card, please include your credit card number and expiration date. Any repair left unpaid or unclaimed after 90 days will be considered abandoned and will be disposed of accordingly. **Please note: non-warranty repair is only available on electronics and model engines.**

Electronics and engines requiring inspection or repair should be shipped to the following address:

Horizon Service Center
4105 Fieldstone Road
Champaign, Illinois 61822

All other Products requiring warranty inspection or repair should be shipped to the following address:

Horizon Product Support
4105 Fieldstone Road
Champaign, Illinois 61822

Please call 877-504-0233 with any questions or concerns regarding this product or warranty.

Safety, Precautions, and Warnings

As the user of this product, you are solely responsible for operating it in a manner that does not endanger yourself and others or result in damage to the product or the property of others.

Carefully follow the directions and warnings for this and any optional support equipment (chargers, rechargeable battery packs, etc.) that you use.

This model is controlled by a radio signal that is subject to interference from many sources outside your control. This interference can cause momentary loss of control so it is necessary to always keep a safe distance in all directions around your model, as this margin will help to avoid collisions or injury.

- Never operate your model with low transmitter batteries.
- Carefully follow the directions and warnings for this and any optional support equipment (chargers, rechargeable battery packs, etc.) that you use.
- Keep all chemicals, small parts and anything electrical out of the reach of children.
- Moisture causes damage to electronics. Avoid water exposure to all equipment not specifically designed and protected for this purpose.

Additional Required Items

Although the Formula Hydro comes fully assembled and ready for action, you will need a few additional items in order to run your boat. You will need the following:

- Blue Thunder™ 20% Fuel (quart) (DYN2320)
- 500cc Fuel Bottle (DYN2003) or
- Fast Tap™ Quart Bottle Spout (DYN2009)
- Glow Plug Wrench (DYN2510)
- Ni-Cd Glow Driver (DYN1925)
- 12 “AA” alkaline batteries (8 for the transmitter and 4 for the receiver)
- Clear 3M tape to seal radio box
- 7.2V Sub-C Battery Pack (DYN1005)

Suggested Field Equipment and Supplies

In addition to the items needed to run the Formula Hydro we recommend that you carry the following in your field box:

- Engine Tuning Screwdriver (DYN2775)
- Replacement Glow Plugs (DYN2508 or DYN2500)
- Hex driver/Allen wrench (1.5mm and 2.5mm)
- Cable grease to lubricate drive shaft (PRB0100, PRB0101)
- Clean towels and rags
- “AA” alkaline batteries
- Adjustable wrench (small)
- 10mm wrench
- Extra propellers
- Threadlock
- 7.2V Battery (DYN1000) for electric starter
- Battery charger (DYN4051) for electric starter battery

Contents

- Assembled Formula Hydro 1/12-Scale RTR
- Pro Boat™ radio transmitter
- Prebuilt boat stand



Section 1: Installing the Receiver and Transmitter Batteries

Receiver Batteries



- 1. Remove the two knurled aluminum nuts that secure the cockpit as shown. Pull the cockpit off the boat.
- 2. Carefully note how the exhaust system is assembled.

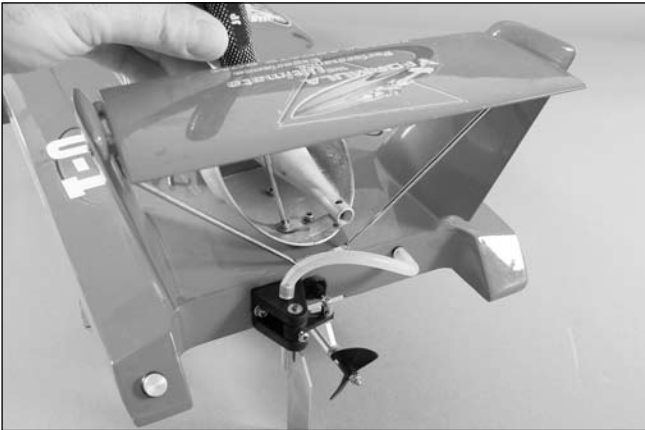

- 3. Use a 2.5mm Allen wrench to remove the tuned pipe mount as shown above.

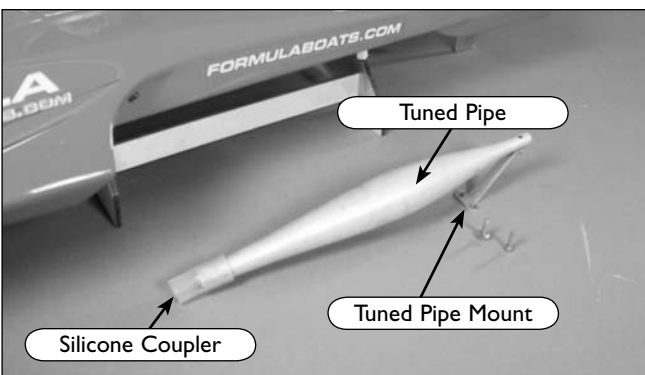

- 4. Carefully remove the tuned pipe by sliding the silicone coupler apart from the exhaust header.

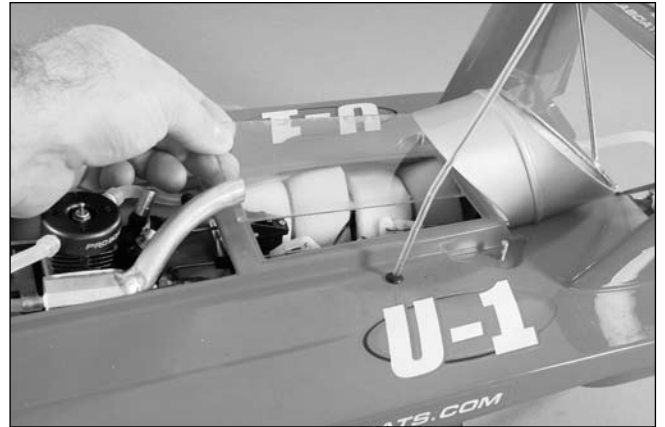

- 5. Remove the clear lid that covers the radio box.

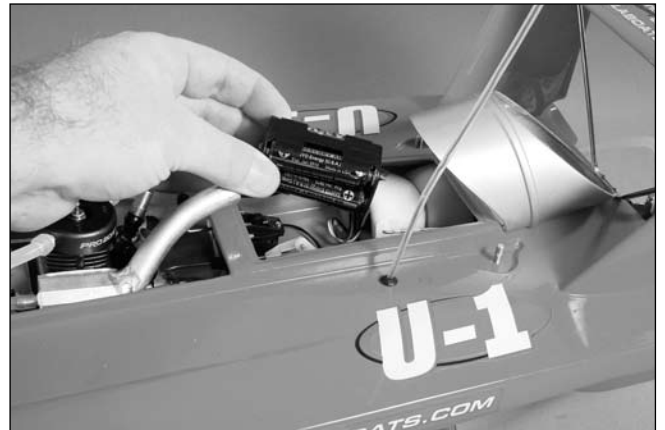

- 6. Remove the dry cell battery holder from the radio box and unwrap the foam around the dry cell battery holder. Install 4 "AA" alkaline batteries into it as shown. Note the proper polarity. Wrap the battery box in foam.

Section 1: Installing the Receiver and Transmitter Batteries

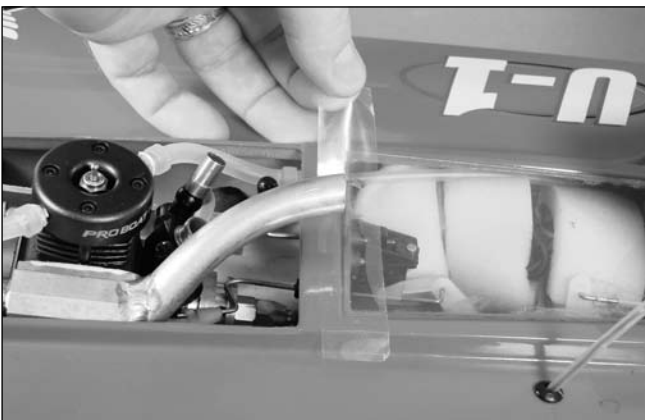
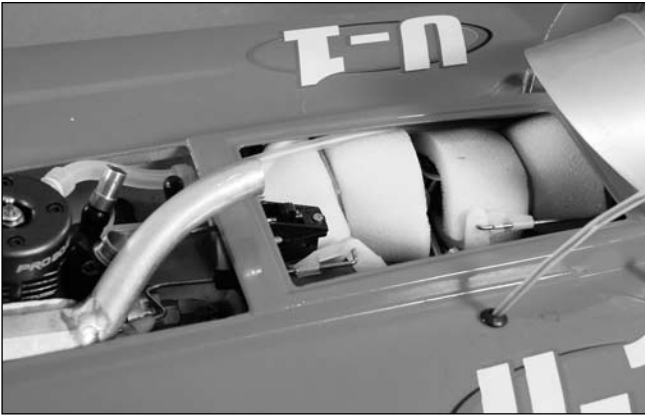

- 7. Re-install the battery holder back into the radio box and properly seal the radio box with clear tape (ABC53009). Failure to properly seal the radio box could result in damage to your radio equipment.

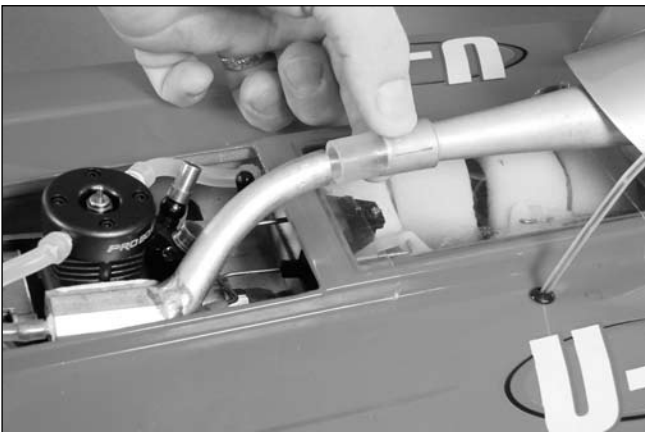

- 8. Re-attach the tuned pipe and coupler to the exhaust manifold.



- 9. Re-install the tuned pipe mount.

Section 1: Installing the Receiver and Transmitter Batteries

Transmitter Batteries

- 1. Remove the transmitter from the box.



- 2. Remove the battery cover on the bottom of the transmitter.



- 3. Install the "AA" batteries into the transmitter. Be aware of the proper polarity when inserting the batteries.



- 4. Replace the battery cover to complete the battery installation.
- 5. Turn on the radio to ensure the batteries have been installed correctly.
- 6. Turn the radio off.

Section 2: Turn Fin

The Formula Hydro comes with the turn fin installed on the right sponson. You will want to run the Formula Hydro in an oval pattern and in an area that will allow you to make right turns (clockwise).

Do not attempt to make tight left hand turns (counterclockwise), or you could flip the boat. If you need to make a left turn, do so in a large diameter turn at slow speeds.

Section 3: Filling the Fuel Tank

We recommend that you use Blue Thunder™ 20% fuel. For maximum performance, we recommend Blue Thunder Race Formula. Blue Thunder fuels are specifically formulated for excellent power and engine protection.

Locate the fuel tank inside the cockpit area and unscrew the lid. Use either the DYN2009 Fast Tap™ quart bottle spout that has been attached to the quart of fuel or the DYN2003 Fuel Bottle to fill the fuel tank with your selection of Blue Thunder fuel. After you have filled the fuel tank and re-installed the lid, wipe away any excess fuel that may have been spilled inside the hull or elsewhere on the boat. Immediately seal the fuel container by putting the lid back on after refueling in order to protect the fuel from moisture.

Section 4: Range Checking the Pro Boat Radio System

Before the first run of the Formula Hydro, range check the radio for proper operation and to ensure proper control movement of the rudder and throttle. Also ensure that the antenna on the boat is extended properly and that all batteries are in working condition.

- 1. With the radio system turned on (transmitter and receiver) and the transmitter antenna down (engine off), walk off 40 to 50 paces from the Formula Hydro.
- 2. Have an assistant remain with the boat to check for proper control movement of the rudder from your transmitter input.

- 3. If everything appears to be operating correctly, raise the antenna and start the engine (refer to Section 5 of this manual and to the separate DYN .18 engine manual). Place the boat in the water and run it (at about 1/3 throttle) close to the shoreline. If the radio system is operating properly, you can begin to run the boat faster and further away from the shoreline.

Note: It is a good idea to range check prior to operating your boat after any repair, installation of new batteries, or at the beginning of each boating season.

Section 5: Starting the Dynamite .18 Engine

Water-Cooled Engine

Because the Dynamite® .18 engine is water-cooled and not aircooled, make sure that you do not run the engine for an extended amount of time outside of the water. Continuously monitor the water outlet when the boat is running to make sure that the water is reaching the engine head. If the water does not reach the head to cool it, the engine will overheat and fail. This could cause permanent damage to the engine.

Pro Mix Carburetor

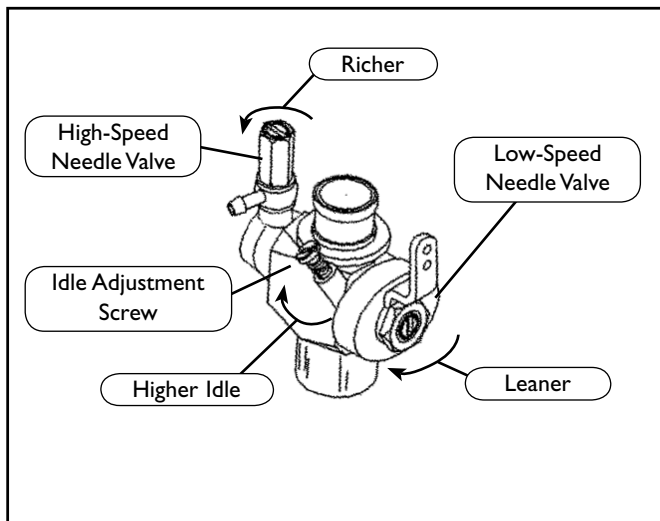

The Dynamite .18 engine comes equipped with the Dynamite Pro Mix Carburetor. Each Pro Mix Carburetor is pre-adjusted at the factory. This setting should be approximately 3½ turns open for the high-speed and 2½ turns open for the low-speed needle. This should give you a slightly “rich” mixture of fuel to the engine. This setting is the safest way to break in your engine. For further details regarding the Pro Mix Carburetor, please consult Section 2 of the Dynamite .18 instruction manual.

Hand-Held Starter



1. Fully charge a 7.2V sub-C battery pack and install it in the starter as shown.



2. Slide the starting wand (which is stored inside the battery cover) into the end of the starter, then replace the battery cover.

Section 5: Starting the Dynamite .18 Engine

Operation

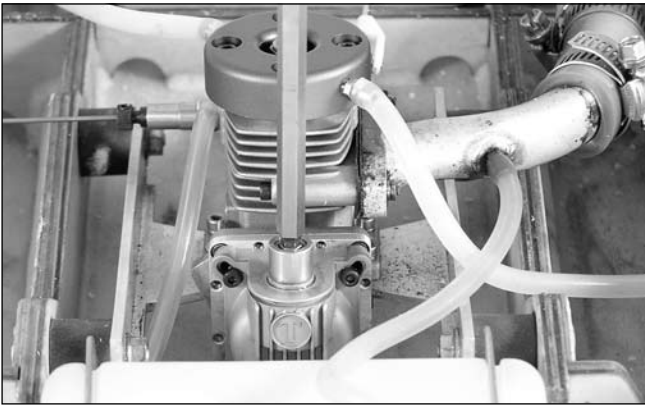

- 3. Turn on your radio system and attach a fully charged glow igniter (DYN1925) to the glow plug. Insert the starting wand into the Tiger Drive and actuate the starting switch until the engine begins to run. If the engine does not start, place your index finger over the carburetor and actuate the starter until you see fuel enter the carburetor through the fuel line.

Note: Stop operation immediately if the engine enters a hydro-locked condition as serious engine damage may occur if operation is continued. Remove the glow plug, invert the boat and operate starter to remove raw fuel before resuming normal operation.

You may have to “blip” the throttle on the transmitter (applying throttle on/off) while trying to start the engine. New engines are harder to start because of the tight piston/sleeve fit. Never start an engine at more than 1/2 throttle, as this will cause over-revving which may cause premature wear and breakage.

During the first tank of fuel, advance the idle via the idle adjustment screw more than normal to prevent stalling at idle due to the rich fuel mixture for break-in. Pinch the fuel line nearest the carburetor to stop the engine.

Breaking In Your Engine

The first start-up of the engine is the most critical moment of the engine’s life, dictating how the engine will perform from that time forward.

During break-in, the low-speed needle should be slightly rich and the high speed needle should be very rich. After a few tanks of fuel, begin to lean the engine out. Adjust the high-speed needle 1/16 of a turn at a time. It generally takes about five to six tanks of fuel before you want to lean out the engine until it supplies good power. Do not skip this process of break-in. Failure to follow this procedure could damage your new engine. For further details on breaking in your engine, please see the separate Dynamite .18 instruction manual.

Note: It is common for an ABC engine to go through a glow plug or two during break-in.

Needle Settings

When adjusting the settings, always adjust the needles in small increments, about 1/16 of a full turn at a time. Do not set the engine too lean, as it shortens the reliability of the engine.

After you have attained the correct needle settings, the engine will have a strong-sounding, high-pitched whine at full speed, and a thin trail of blue/white smoke will come from the exhaust.

Idle Adjustment

The last setting to set is the idle screw. To obtain a higher idle, turn the idle screw clockwise; for lower idle, turn the idle screw counterclockwise.

Replacement Parts

In the event that you need to replace an engine part, there is a complete parts listing in the Dynamite .18 instruction manual. Exploded views will help you to select the correct parts and make minor repairs.

Head Shims

Several head shims are added at the factory to make the engine easier to start when new. After break-in, you may remove all but one of these shims to increase compression and power.

Maintenance

Lube the gears inside the drive with waterproof grease every 30 hours of use. Check all screws for tightness after each run.

Section 6: Maintenance

Lubrication

It is important to lubricate the flex shaft of the Formula Hydro with silicone cable grease after every two hours of operation. Do not forget to do this or flex shaft damage can occur. You can purchase this silicone grease at your local hobby store (PRB0100 or PRB0101). To lubricate the drive shaft, follow these simple instructions.

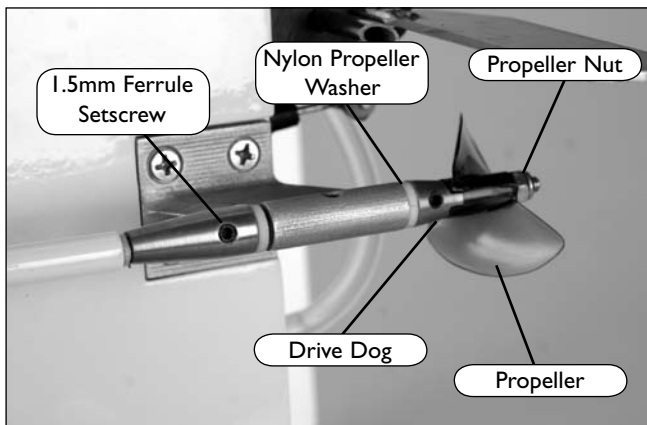
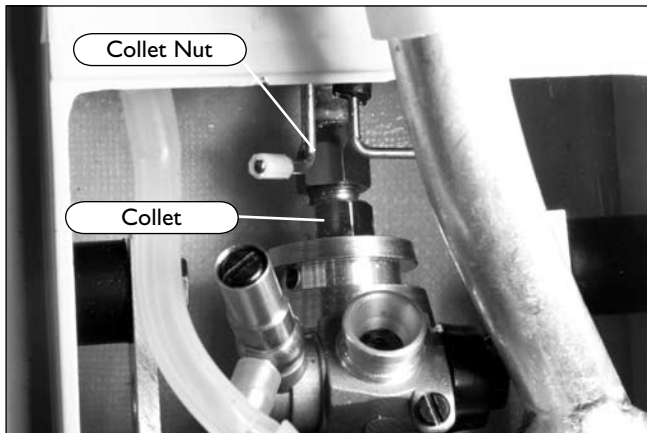

- 1. Carefully note how the drive shaft and prop are presently installed. This is important so that when you have finished lubricating the drive shaft, you can correctly re-install it.

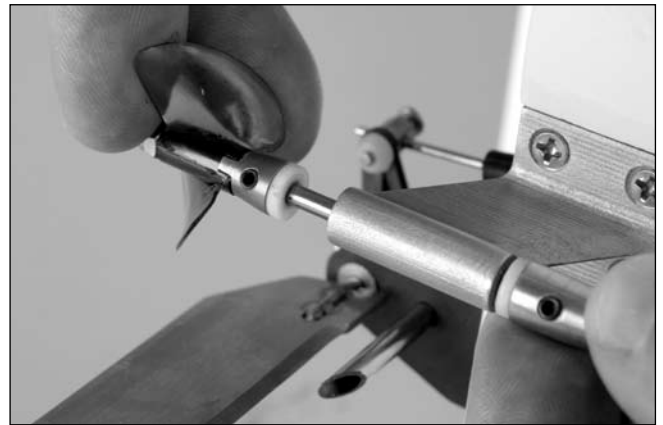

- 2. Loosen and remove the 1.5mm setscrew that holds the propeller shaft. Remove the propeller and shaft from the aluminum strut.



- 3. Insert a hex driver into the hole located on the flywheel to lock the crankshaft in place. Then use an 10mm wrench to loosen the collet nut.

Section 6: Maintenance

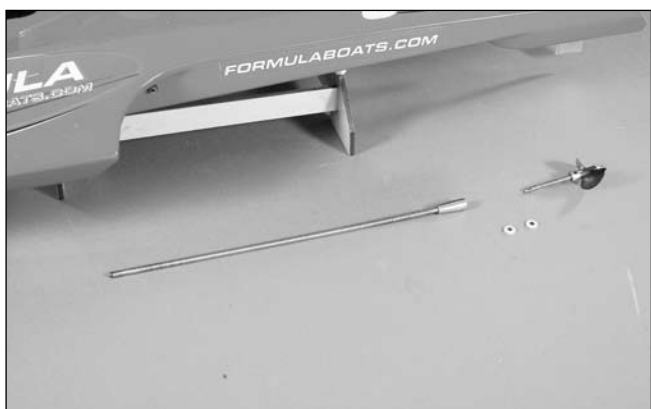
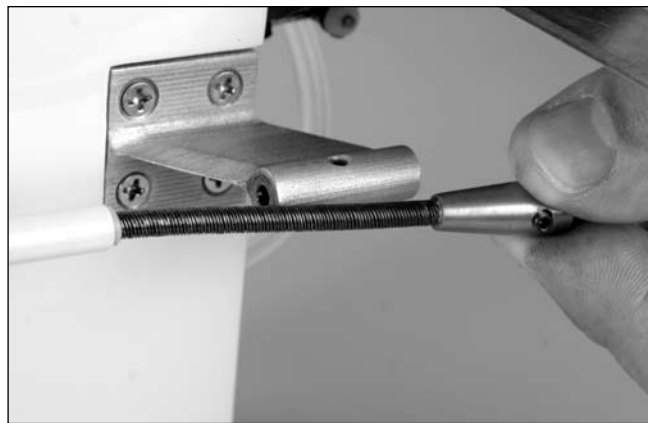
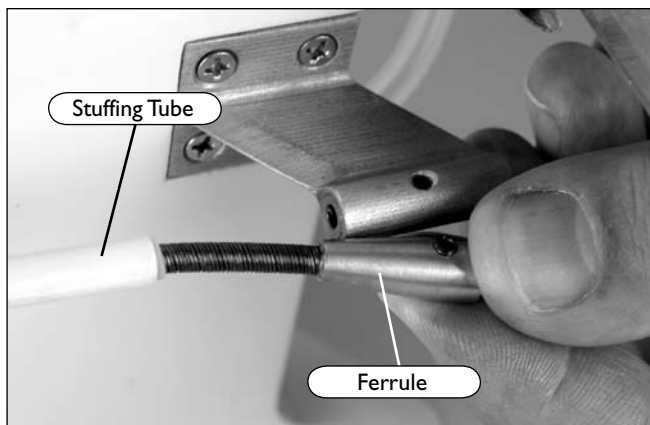

- 4. Carefully pull the ferrule away from the stuffing tube. You will need to pull at an angle to clear the aluminum strut.

- 6. Carefully re-install the flex shaft and nylon bushing, making certain that you correctly tighten the collet nut. Next, re-install the drive shaft and propeller and tighten the setscrew on the flat of the drive shaft. Use screw locking compound to secure the setscrew.



- 5. Liberally lubricate the entire length of the flex shaft with silicone cable grease as shown.

Section 7: Troubleshooting Guide

Problem	Possible Solution
Engine will not start	Check needles and make changes back to factory settings if necessary Improper needle setting Out of fuel Improper fuel Improper glow plug Glow igniter not charged Dead glow plug Flooded engine
Engine starts, then dies	Pressure line blocked or unhooked Reset needles to baseline setting Improper needle settings
Engine starts and runs for several minutes, then dies	Bad glow plug Idle speed set too low Improper needle settings Overheated engine Glow plug failed due to lean engine setting

Appendix

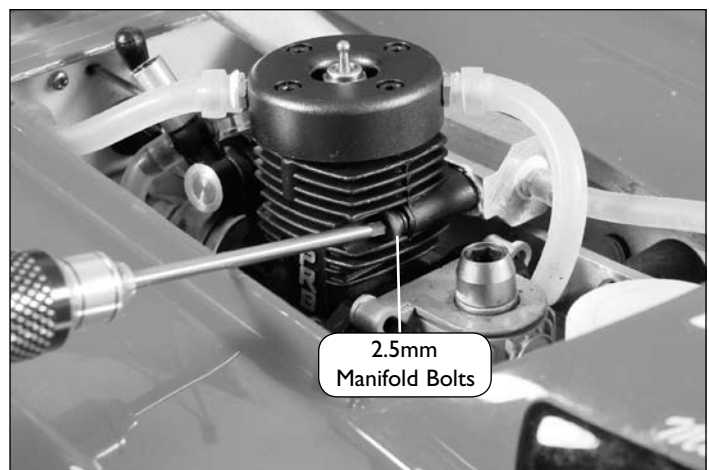
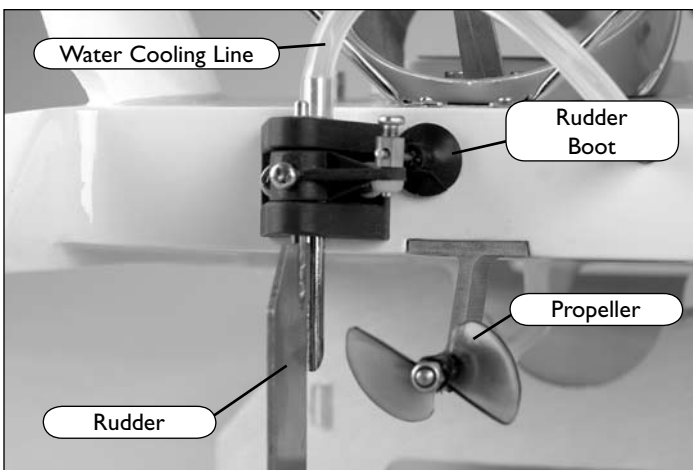
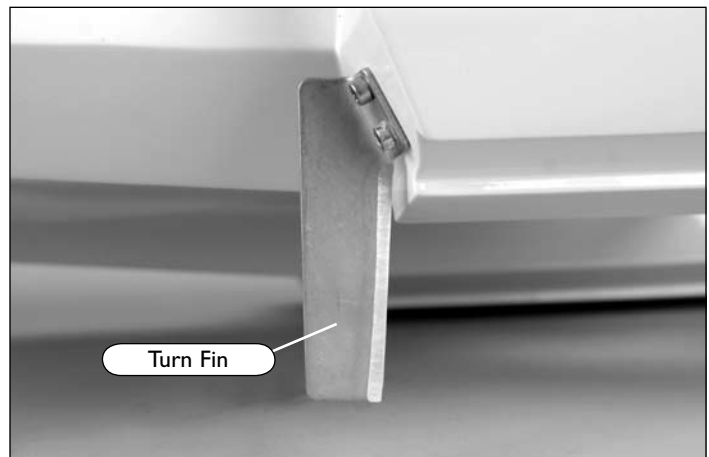
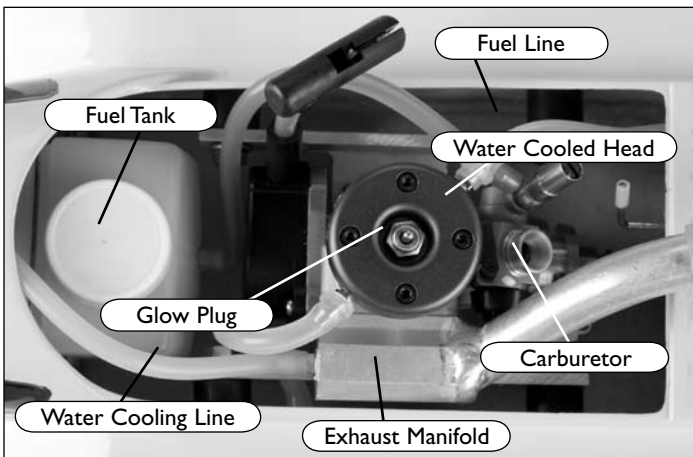

Section 8: Formula Hydro Replacement Parts

In the event that you need to purchase replacement parts for your engine or the Formula Hydro, please see your local hobby store. You can also purchase them from Horizon Hobby by calling 1-800-338-4639 or shop online @ www.horizonhobby.com

Stock #	Description
PRB2203	Exhaust Cover
PRB2207	Fuel Tank
PRB2208	Manifold
PRB2209	Tuned Pipe
PRB2210	Manifold Pressure Fitting
PRB2211	Coupler Tubing
PRB2212	Tuned Pipe Mount
PRB0150	Propeller
PRB2215	Flywheel
PRB2217	Prop Washer
PRB2218	Prop Nut
PRB2219	Nylon Washer
PRB2220	Rudder
PRB2221	Rudder Bracket
PRB2222	Turn Fin
PRB2223	Push Rod Connector
PRB2224	Silicone Tubing
PRB2225	Battery Box/Switch
PRB2226	Antenna Tube
PRB2228	Rubber Boot
PRB2229	Cockpit Securing Nuts
PRB2231	Throttle Push Rod
PRB2232	Boat Stand
PRB3201	Hull
PRB3202	Cockpit
PRB3203	Wing
PRB3204	Decal Sheet
PRB2504	Stabilizer Struts
PRB2506	Flexshaft /w Ferrule
PRB2507	Drivedog /Prop Shaft
PRB2508	Propeller Strut
PRB2509	Cable Collet
PRB2511	Switch Mount
PRB2512	Motor Mount Hardware
PRB2513	Flex Shaft Liner
SUL689	Tiger Drive .12-.18
PRB8100	Marine Starting System .12-.18



www.proboatmodels.com

Building and Operating Notes:

Lined area for notes with 15 horizontal lines.



© 2007 Horizon Hobby, Inc.
4105 Fieldstone Road
Champaign, Illinois 61822
(877) 504-0233
www.horizonhobby.com
www.proboatmodels.com