















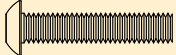













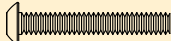
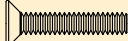

# FASTENERS // VERBINDUNGSELEMENTE // ÉLÉMENTS DE FIXATION // ELEMENTI DI FISSAGGIO //////////////////////////////////////

 <b>VTR235095 X 10</b> M2,5 x 4mm Button Head Screw M2,5 x 4mm Halbrundschraben Vis à tête bombée M2,5 x 4mm Viti testa tonda M2,5 x 4mm	 <b>VTR235122 X 10</b> M4 x 10mm Button Head Screw M4 x 10mm Halbrundschraben Vis à tête bombée M4 x 10mm Viti testa tonda M4 x 10mm	 <b>VTR235320 X 10</b> M3 x 3mm Cup Point Set Screw M3 x 3mm Ringschneide Gewindestift Vis Imbus à bout cuvette M3 x 3mm Tazza punto grani M3 x 3mm	 <b>VTR236013 X 10</b> M2,5 Nylock Nut M2,5 Mutter Nylock Écrou Nylock M2,5 Dado Nylock M2,5	 <b>VTR236104 X 10</b> 2,5mm x 4,6mm x ,5mm Washer 2,5mm x 4,6mm x ,5mm Unterlegscheiben Rondelle 2,5mm x 4,6mm x ,5mm Rondella 2,5mm x 4,6mm x ,5mm	 <b>VTR237014 X 2</b> 6mm x 12mm x 4mm Ball Bearing 6mm x 12mm x 4mm Kugellager Roulement 6mm x 12mm x 4mm Cuscinetto a sfere 6mm x 12mm x 4mm
 <b>VTR235098 X 10</b> M2,5 x 8mm Button Head Screw M2,5 x 8mm Halbrundschraben Vis à tête bombée M2,5 x 8mm Viti testa tonda M2,5 x 8mm	 <b>VTR235125 X 10</b> M4 x 20mm Button Head Screw M4 x 20mm Halbrundschraben Vis à tête bombée M4 x 20mm Viti testa tonda M4 x 20mm	 <b>VTR235343 X 10</b> M4 x 4mm Cup Point Set Screw M4 x 4mm Ringschneide Gewindestift Vis Imbus à bout cuvette M4 x 4mm Tazza punto grani M4 x 4mm	 <b>VTR236014 X 10</b> M3 Nylock Nut M3 Mutter Nylock Écrou Nylock M3 Dado Nylock M3	 <b>VTR236076 X 10</b> 3,2mm x 7mm x ,5mm Washer 3,2mm x 7mm x ,5mm Unterlegscheiben Rondelle 3,2mm x 7mm x ,5mm Rondella 3,2mm x 7mm x ,5mm	 <b>VTR237019 X 2</b> 8mm x 12mm x 3.5mm Ball Bearing 8mm x 12mm x 3.5mm Kugellager Roulement 8mm x 12mm x 3.5mm Cuscinetto a sfere 8mm x 12mm x 3.5mm
 <b>VTR235107 X 10</b> M3 x 10mm Button Head Screw M3 x 10mm Halbrundschraben Vis à tête bombée M3 x 10mm Viti testa tonda M3 x 10mm	 <b>VTR235174 X 10</b> M3 x 6mm Flat Head Screw M3 x 6mm Flachkopfschrauben Vis à tête fraisée M3 x 6mm Viti a testa piatta M3 x 6mm	 <b>VTR235013 X 10</b> M2,5 x 8mm Cap Head Screw M2,5 x 8mm Innensechskantschrauben Vis à tête creuse M2,5 x 8mm Viti a testa bombata M2,5 x 8mm	 <b>VTR236015 X 10</b> M4 Nylock Nut M4 Mutter Nylock Écrou Nylock M4 Dado Nylock M4	 <b>VTR237003 X 2</b> 4mm x 8mm x 3mm Ball Bearing 4mm x 8mm x 3mm Kugellager Roulement 4mm x 8mm x 3mm Cuscinetto a sfere 4mm x 8mm x 3mm	 <b>VTR237009 X 2</b> 5mm x 13mm x 4mm Ball Bearing 5mm x 13mm x 4mm Kugellager Roulement 5mm x 13mm x 4mm Cuscinetto a sfere 5mm x 13mm x 4mm
 <b>VTR235110 X 10</b> M3 x 16mm Button Head Screw M3 x 16mm Halbrundschraben Vis à tête bombée M3 x 16mm Viti testa tonda M3 x 16mm	 <b>VTR235176 X 10</b> M3 x 10mm Flat Head Screw M3 x 10mm Flachkopfschrauben Vis à tête fraisée M3 x 10mm Viti a testa piatta M3 x 10mm	 <b>VTR235023 X 10</b> M3 x 6mm Cap Head Screw M3 x 6mm Innensechskantschrauben Vis à tête creuse M3 x 6mm Viti a testa bombata M3 x 6mm	 <b>VTR236016 X 10</b> M5 Nylock Nut M5 Mutter Nylock Écrou Nylock M5 Dado Nylock M5	 <b>VTR237004 X 2</b> 5mm x 10mm x 4mm Ball Bearing 5mm x 10mm x 4mm Kugellager Roulement 5mm x 10mm x 4mm Cuscinetto a sfere 5mm x 10mm x 4mm	 <b>VTR237029 X 2</b> 12mm x 18mm x 4mm Ball Bearing 12mm x 18mm x 4mm Kugellager Roulement 12mm x 18mm x 4mm Cuscinetto a sfere 12mm x 18mm x 4mm
 <b>VTR235112 X 10</b> M3 x 20mm Button Head Screw M3 x 20mm Halbrundschraben Vis à tête bombée M3 x 20mm Viti testa tonda M3 x 20mm	 <b>VTR235179 X 10</b> M3 x 16mm Flat Head Screw M3 x 16mm Flachkopfschrauben Vis à tête fraisée M3 x 16mm Viti a testa piatta M3 x 16mm	 <b>VTR236044 X 10</b> M5 Nylock Flanged Serrated Nut M5 Mutter Nylock angeflanscht gezackt Écrou Nylock bride en dents de scie M5 Dado Nylock flangiato seghettato M5	 <b>VTR237013 X 2</b> 6mm x 10mm x 3mm Ball Bearing 6mm x 10mm x 3mm Kugellager Roulement 6mm x 10mm x 3mm Cuscinetto a sfere 6mm x 10mm x 3mm	 <b>VTR237028 X 2</b> 10mm x 15mm x 4mm Nylon Retainer Ball Bearing Nylonkugellager gekapstelt 10 x 15 x 4mm Roulement 10mmx15mmx4mm à cage nylon Cuscinetto a sfere con fermo in nylon 10mm x 15mm x 4mm	
 <b>VTR235187 X 10</b> M4 x 10mm Flat Head Screw M4 x 10mm Flachkopfschrauben Vis à tête fraisée M4 x 10mm Viti a testa piatta M4 x 10mm	 <b>VTR235227 X 10</b> U-Joint Screw: Hal U-Verbinder Schraube: Hal Vis de liaison: Hal Vite con giunto a U: Hal	 <b>VTR236137 X 10</b> E-Clip, 5mm E-Clip, 5mm E-Clip, 5mm E-Clip, 5mm	 <b>VTR236138 X 10</b> C-Clip, 6mm C-Clip, 6mm C-Clip, 6mm C-Clip, 6mm		

# REPLACEMENT PARTS // ERSATZTEILE // PIÈCES DE RECHANGE // PEZZI DI RICAMBIO //

Part #   Nummer Numéro   Codice	Description	Beschreibung	Description	Descrizione
DYN4833	Dynamite Fuze 540 4-Pole 3300Kv Sensorless Brushless Motor	DYN4833T Dynamite Fuze 540 4-Pole 3300Kv Sensorloser Brushless Motor	Moteur brushless sensorless Dyna- mite Fuze 540 4-pôles 3300kV	DYN4833T Dynamite Fuze 540 4-Poli 3300Kv Motore Sensorless Brushless
DYN4850	Dynamite Fuze 70A Waterproof Sensorless Brushless ESC	DYN4850T Dynamite Fuze 70A spritzwasserdichter Sensorloser Brushless Regler	Contrôleur étanche brushless sensorless Dynamite Fuze 70A	DYN4850T Dynamite Fuze 70A ESC impermeabile Sensorless Brushless
SPM2322	DX2E DSM 2-Channel Surface Radio	SPMR2400 DX2E DSM 2-Kanal Surface Fernsteuerung	Radio 2 voies DX2E DSM, surface	SPMR2400 DX2E DSM radio 2 canali
SPMSRS4200	SRS4200 4-Channel DSMR AVC Receiver, Waterproof	SRS4200 4-Kanal DSMRAVC Empfän- ger, Spritzwassergeschützt	Récepteur SRS4200 4 voies DSMR AVC étanche	Ricevitore SRS4200 4-canali DSMR AVC, impermeabile
SPMSS6170	Standard Digital Surface Servo, Waterproof	Standard Digital Surface Servo, Spritz- wassergeschützt	Servo standard digital étanche pour voiture	Servo car standard digitale, imper- meabile
VTR243005	Shock, Rod End Tool: GLU	Stoßdämpfereinstellwerkzeug: GLU	Outil à amortisseur et biellette: GLU	Ammortizzatore, attrezzo termi- nale asta: GLU

# REAR // HECK // ARRIERE // POSTERIORE //////////////////////////////////////

Part #   Nummer Numéro   Codice	Description	Beschreibung	Description	Descrizione
VTR43031	Wheel (2): RAL	Räder (2): RAL	Jantes (2): RAL	Ruote (2): RAL
VTR43032	Tire w/Foam (2): RAL	Reifen m. Schaum (2): RAL	Pneu avec insert en mousse (2): RAL	Gomme c/espanso (2): RAL
VTR231019	Camber & Steering Links: Hal	Spur- u. Sturzstangen: Hal	Biellettes de carrossage et de direction: Hal	Collegamenti camber & sterzo: Hal
VTR231021	Hinge Pin Brace, Fr/Rr: Hal	Querlenkerstifthalter, v/h: Hal	Renfort de cellule Av/arr: Hal	Supporto perno cerniera, anter/ poster: Hal
VTR231027	Bulkhead, Fr/Rr: Hal	Chassishalter v/h: Hal	Cellule Av/arr: Hal	Paratia, anter/poster: Hal
VTR231029	Skid Plate, Fr/Rr: Rap	Unterfahrschutz Chassis v/h: Rap	Plaque de protection inférieure Av/arr: Rap	Piastra protezione, anter/poster: Rap
VTR231031	Bumper, Fr/Rr: RAL	Stoßfänger v/h: RAL	Pare-choc Av/Arr : RAL	Paraurti ant/post: RAL
VTR231032	Body Post, Fr/Rr: RAL	Karosseriehalter: RAL	Supports de carrosserie Av/Arr : RAL	Supporto carrozzeria ant/post: RAL
VTR232054	Driveshaft (2), Fr/Rr: Hal	Antriebswelle (2) v/h: Hal	Cardan Av/arr (2): Hal	Trascinatori (2), anter/poster: Hal
VTR232056	Metal Bevel Gear & Pinion: Hal, V100	Stirnrad Metall + Ritzel: Hal, V100	Couronne et pignon coniques en métal: Hal, V100	Coppia conica in metallo & pig- none: Hal, V100
VTR232057	Pin & Stopper Ring: Hal	Pin u. Stopper Ring: Hal	Goupille et anneau de retenue: Hal	Perno & anello di fermo: Hal
VTR232058	Shaft, Bevel Gear: Hal	Stirnrad u. Welle: Hal	Axe de pignon d'attaque: Hal	Albero, coppia conica: Hal
VTR234009	Rear Upper & Lower Track Rods: Twin Hammers	Vaterra Aufhängungssatz Oben/ Unten	Tirants supérieurs et inférieurs arrière	Aste superiore & inferiore poster.
VTR234020	Suspension Arms (2), Fr/Rr: Hal	Querlenker v/h: Hal	Triangle de suspension Av/arr (2): Hal	Bracci sospensioni (2), anter/ poster: Hal
VTR234022	Rear Hub Carriers: Hal	Radträger hinten: Hal	Fusées arrières: Hal	Supporto mozzo posteriore: Hal
VTR234023	Shock Tower, Fr/Rr: Hal	Dämpferbrücke, v/h: Hal	Support d'amortisseur Av/arr: Hal	Supporto ammortizzatore, anter/ poster: Hal
VTR235107	M3 x 10mm Button Head Screw	M3 x 10mm Halbrundschauben	Vis à tête bombée M3 x 10mm	Viti testa tonda M3 x 10mm
VTR235110	M3 x 16mm Button Head Screw	M3 x 16mm Halbrundschauben	Vis à tête bombée M3 x 16mm	Viti testa tonda M3 x 16mm
VTR235112	M3 x 20mm Button Head Screw	M3 x 20mm Halbrundschauben	Vis à tête bombée M3 x 20mm	Viti testa tonda M3 x 20mm
VTR235179	M3 x 16mm Flat Head Screw	M3 x 16mm Flachkopfschrauben	Vis à tête fraisée M3 x 16mm	Viti a testa piatta M3 x 16mm
VTR235187	M4 x 10mm Flat Head Screw	M4 x 10mm Flachkopfschrauben	Vis à tête fraisée M4 x 10mm	Viti a testa piatta M4 x 10mm

Part #   Nummer Numéro   Codice	Description	Beschreibung	Description	Descrizione
VTR235227	U-Joint Screw: Hal	U-Verbinder Schraube: Hal	Vis de liaison: Hal	Vite con giunto a U: Hal
VTR236014	M3 Nylock Nut	M3 Mutter Nylock	Écrou Nylock M3	Dado Nylock M3
VTR236044	M5 Nylock Flanged Serrated Nut	M5 Mutter Nylock angeflanscht gezackt	Écrou Nylock bride en dents de scie M5	Dado Nylock flangiato seghettato M5
VTR236137	E-Clip, 5mm	E-Clip, 5mm	E-Clip, 5mm	E-Clip, 5mm
VTR237004	5 x 10 x 4mm Ball Bearing	5 x 10 x 4mm Kugellager	Roulement 5 x 10 x 4mm	Cuscinetto a sfere 5 x 10 x 4mm
VTR237014	6 x 12 x 4mm Ball Bearing	6 x 12 x 4mm Kugellager	Roulement 6 x 12 x 4mm	Cuscinetto a sfere 6 x 12 x 4mm
VTR237019	8 x 12 x 3.5mm Ball Bearing	8 x 12 x 3.5mm Kugellager	Roulement 8 x 12 x 3.5mm	Cuscinetto a sfere 8 x 12 x 3.5mm
VTR242019	Hex Adapter, 12mm x 6mm: GLU	Radmitnehmer 12mm x 6mm: GLU	Hexagone 12 x 6mm: GLU	Adattatore esagonale 12 x 6mm: GLU
VTR246001	Screw Pin, Clip Post (10): GLU	Stiftschraube (10): GLU	Supports de clips avec goupilles (10): GLU	Perni viti clip (10): GLU
VTR246012	Hinge Pin, 3 x 63.5mm (2): Hal	Querlenkerstift, 3 x 63.5mm (2): Hal	Axe de suspension 3 x 63.5mm (2): Hal	Perno cerniera, 3 x 63.5mm (2): Hal
VTR246014	Hinge Pin, 3.2 x 40mm (2): Hal	Querlenkerstift, 3.2 x 40mm (2): Hal	Axe de suspension 3.2 x 40mm (2): Hal	Perno cerniera, 3.2 x 40mm (2): Hal



**FRONT // VORNE // AVANT // ANTERIORE** //////////////////////////////////////

Part #   Nummer Numéro   Codice	Description	Beschreibung	Description	Descrizione
VTR43031	Wheel (2): RAL	Räder (2): RAL	Jantes (2): RAL	Ruote (2): RAL
VTR43032	Tire w/Foam (2): RAL	Reifen m. Schaum (2): RAL	Pneu avec insert en mousse (2): RAL	Gomme c/espanso (2): RAL
VTR231019	Camber & Steering Links: Hal	Spur- u. Sturzstangen: Hal	Biellettes de carrossage et de direction: Hal	Collegamenti camber & sterzo: Hal
VTR231021	Hinge Pin Brace, Fr/Rr: Hal	Querlenkerstifthalter, v/h: Hal	Renfort de cellule Av/arr: Hal	Supporto perno cerniera, anter/poster: Hal
VTR231026	Servo Arms & Bellcranks: Hal	Servoarm u. Lenkhebel: Hal	Bras de servo et renvois de direction: Hal	Bracci servo & squadrette: Hal
VTR231027	Bulkhead, Fr/Rr: Hal	Chassishalter v/h: Hal	Cellule Av/arr: Hal	Paratia, anter/poster: Hal
VTR231029	Skid Plate, Fr/Rr: Rap	Unterfahrschutz Chassis v/h: Rap	Plaque de protection inférieure Av/arr: Rap	Piastra protezione, anter/poster: Rap
VTR231031	Bumper, Fr/Rr: RAL	Stoßfänger v/h: RAL	Pare-choc Av/Arr : RAL	Paraurti ant/post: RAL
VTR231032	Body Post, Fr/Rr: RAL	Karosseriehalter: RAL	Supports de carrosserie Av/Arr : RAL	Supporto carrozzeria ant/post: RAL
VTR232054	Driveshaft (2), Fr/Rr: Hal	Antriebswelle (2) v/h: Hal	Cardan Av/arr (2): Hal	Trascinatori (2), anter/poster: Hal
VTR232056	Metal Bevel Gear & Pinion: Hal, V100	Stirnrad Metall + Ritzel: Hal, V100	Couronne et pignon coniques en métal: Hal, V100	Coppia conica in metallo & pignone: Hal, V100
VTR232057	Pin & Stopper Ring: Hal	Pin u. Stopper Ring: Hal	Goupille et anneau de retenue: Hal	Perno & anello di fermo: Hal
VTR232058	Shaft, Bevel Gear: Hal	Stirnrad u. Welle: Hal	Axe de pignon d'attaque: Hal	Albero, coppia conica: Hal
VTR234009	Rear Upper & Lower Track Rods: Twin Hammers	Vaterra Aufhängungssatz Oben/ Unten	Tirants supérieurs et inférieurs arrière	Aste superiore & inferiore poster.
VTR234020	Suspension Arms (2), Fr/Rr: Hal	Querlenker v/h: Hal	Triangle de suspension Av/arr (2): Hal	Bracci sospensioni (2), anter/poster: Hal
VTR234021	Castor Blocks & Spindles: Hal	Achsschenkelträger: Hal	Etriers porte fusées et fusées: Hal	Blocchi mobili & fusi: Hal
VTR234023	Shock Tower, Fr/Rr: Hal	Dämpferbrücke, v/h: Hal	Support d'amortisseur Av/arr: Hal	Supporto ammortizzatore, anter/poster: Hal
VTR235107	M3 x 10mm Button Head Screw	M3 x 10mm Halbrundschrauben	Vis à tête bombée M3 x 10mm	Viti testa tonda M3 x 10mm
VTR235110	M3 x 16mm Button Head Screw	M3 x 16mm Halbrundschrauben	Vis à tête bombée M3 x 16mm	Viti testa tonda M3 x 16mm
VTR235112	M3 x 20mm Button Head Screw	M3 x 20mm Halbrundschrauben	Vis à tête bombée M3 x 20mm	Viti testa tonda M3 x 20mm

Part #   Nummer Numéro   Codice	Description	Beschreibung	Description	Descrizione
VTR235122	M4 x 10mm Button Head Screw	M4 x 10mm Halbrundschauben	Vis à tête bombée M4 x 10mm	Viti testa tonda M4 x 10mm
VTR235174	M3 x 6mm Flat Head Screw	M3 x 6mm Flachkopfschrauben	Vis à tête fraisée M3 x 6mm	Viti a testa piatta M3 x 6mm
VTR235176	M3 x 10mm Flat Head Screw	M3 x 10mm Flachkopfschrauben	Vis à tête fraisée M3 x 10mm	Viti a testa piatta M3 x 10mm
VTR235179	M3 x 16mm Flat Head Screw	M3 x 16mm Flachkopfschrauben	Vis à tête fraisée M3 x 16mm	Viti a testa piatta M3 x 16mm
VTR235187	M4 x 10mm Flat Head Screw	M4 x 10mm Flachkopfschrauben	Vis à tête fraisée M4 x 10mm	Viti a testa piatta M4 x 10mm
VTR235227	U-Joint Screw: Hal	U-Verbinder Schraube: Hal	Vis de liaison: Hal	Vite con giunto a U: Hal
VTR236014	M3 Nylock Nut	M3 Muttern Nylock	Écrou Nylock M3	Dado Nylock M3
VTR236015	M4 Nylock Nut	M4 Muttern Nylock	Écrou Nylock M4	Dado Nylock M4
VTR236044	M5 Nylock Flanged Serrated Nut	M5 Muttern Nylock angeflanscht gezackt	Écrou Nylock bride en dents de scie M5	Dado Nylock flangiato seghettato M5
VTR236137	E-Clip, 5mm	E-Clip, 5mm	E-Clip, 5mm	E-Clip, 5mm
VTR237003	4mm x 8mm x 3mm Ball Bearing	4mm x 8mm x 3mm Kugellager	Roulement 4mm x 8mm x 3mm	Cuscinetto a sfere 4mm x 8mm x 3mm
VTR237004	5mm x 10mm x 4mm Ball Bearing	5mm x 10mm x 4mm Kugellager	Roulement 5mm x 10mm x 4mm	Cuscinetto a sfere 5mm x 10mm x 4mm
VTR237014	6mm x 12mm x 4mm Ball Bearing	6mm x 12mm x 4mm Kugellager	Roulement 6mm x 12mm x 4mm	Cuscinetto a sfere 6mm x 12mm x 4mm
VTR237019	8mm x 12mm x 3.5mm Ball Bearing	8mm x 12mm x 3.5mm Kugellager	Roulement 8mm x 12mm x 3.5mm	Cuscinetto a sfere 8mm x 12mm x 3.5mm
VTR242019	Hex Adapter, 12mm x 6mm: GLU	Radmitnehmer 12mm x 6mm: GLU	Hexagone 12 x 6mm: GLU	Adattatore esagonale 12 x 6mm: GLU
VTR246001	Screw Pin, Clip Post (10): GLU	Stiftschraube (10): GLU	Supports de clips avec goupilles (10): GLU	Perni viti clip (10): GLU
VTR246002	Ball Stud, 4.8mm x 12mm (10): GLU	Kugelkopf Set, 4,8 x 12mm (10): GLU	Rotules 4.8mm x 12mm (10): GLU	Attacco a sfera, 4.8mm x 12mm (10): GLU
VTR246012	Hinge Pin, 3mm x 63.5mm (2): Hal	Querlenkerstift, 3mm x 63.5mm (2): Hal	Axe de suspension 3mm x 63.5mm (2): Hal	Perno cerniera, 3mm x 63.5mm (2): Hal
VTR246013	Hinge Pin, 3mm x 16mm (2): Hal	Querlenkerstift, 3mm x 16mm (2): Hal	Axe de suspension 3mm x 16mm (2): Hal	Perno cerniera, 3mm x 16mm (2): Hal

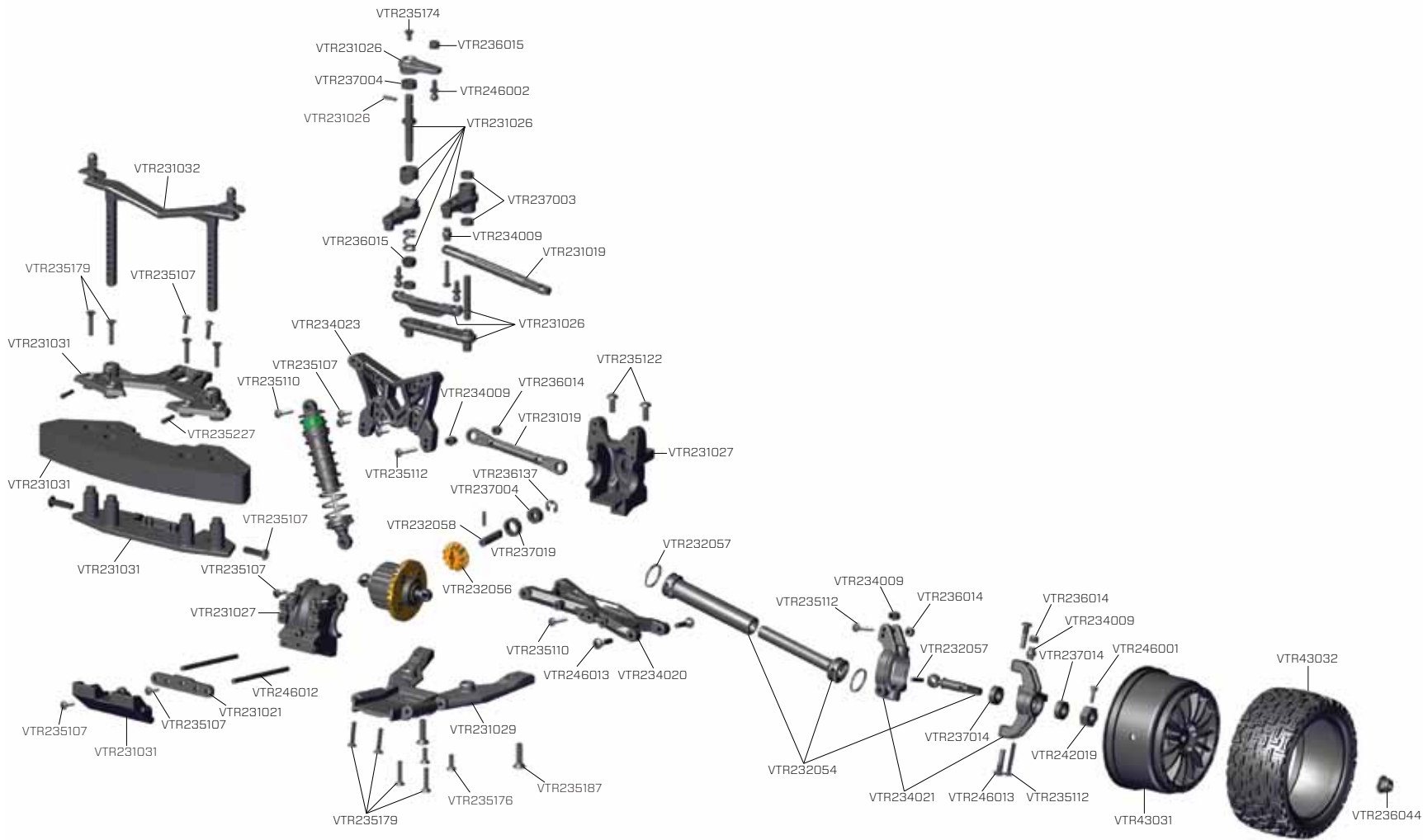



# CHASSIS // CHASSIS // CHÂSSIS // TELAIO //////////////////////////////////////

Part #   Nummer Numéro   Codice	Description	Beschreibung	Description	Descrizione
DYN4833	Dynamite Fuze 540 4-Pole 3300Kv Sensorless Brushless Motor	DYN4833T Dynamite Fuze 540 4-Pole 3300Kv Sensorloser Brushless Motor	Moteur brushless sensorless Dynamite Fuze 540 4-pôles 3300kV	DYN4833T Dynamite Fuze 540 4-Poli 3300Kv Motore Sensorless Brushless
DYN4850	Dynamite Fuze 70A Waterproof Sensorless Brushless ESC	DYN4850T Dynamite Fuze 70A spritzwasserdichter Sensorloser Brushless Regler	Contrôleur étanche brushless sensorless Dynamite Fuze 70A	DYN4850T Dynamite Fuze 70A ESC impermeabile Sensorless Brushless
SPMSRS4200	SRS4200 4-Channel DSMR AVC Receiver, Waterproof	SRS4200 4-Kanal DSMRAVC Empfänger, Spritzwassergeschützt	Récepteur SRS4200 4 voies DSMR AVC étanche	Ricevitore SRS4200 4-canali DSMR AVC, impermeabile
SPMSS6170	Standard Digital Surface Servo, Waterproof	Standard Digital Surface Servo, Spritzwassergeschützt	Servo standard digital étanche pour voiture	Servo car standard digitale, impermeabile
VTR231022	Battery Foam: Hal	Schaumstoff f. Akku: Hal	Mousse pour batterie: Hal	Spugna batteria: Hal
VTR231024	Battery Strap & Pivot: Hal	Verschlussriegel f. Akku: Hal	Support de batterie avec pivot: Hal	Fermo batteria e perno: Hal
VTR231025	Receiver Mount & Cover: Hal	Empfängerhalter u. Abdeckung: Hal	Support de récepteur avec couvercle: Hal	Supporto ricevitore e coperchio: Hal
VTR231026	Servo Arms & Bellcranks: Hal	Servoarm u. Lenkhebel: Hal	Bras de servo et renvois de direction: Hal	Bracci servo & squadrette: Hal
VTR231028	Chassis: Rap	Chassis: Rap	Châssis: Rap	Telaio: Rap
VTR232029	Pinion Gear 20T, 48P, M3 x 3 Set Screw	Ritzel 20Z, 48P, M3 x 3 Madenschraube	Pignon 20T, 48p et vis M3 x 3	Pignone 20T, 48P, M3x3 Set viti
VTR232055	Slipper Hub, Spring, Shaft: Hal	Welle u. Feder Rutschkupplung: Hal	Moyeux, ressort et axe de slipper: Hal	Mozzo, molla e albero slipper: Hal
VTR232061	Slipper Cover/Spacers & Bearing Holders: Hal	Abdeckung Rutschkupplung, Distanzstück u. Lager, Halter: Hal	Couvercle, entretoise et support de roulement de slipper: Hal	Copertura/distanziale e supporti cuscinetti slipper: Hal
VTR232064	Motor Mount: Rap	Motorträger: Rap	Support moteur: Rap	Supporto motore: Rap
VTR232065	Slipper Cover: Rap	Abdeckung Rutschkupplung: Rap	Couvercle de slipper: Rap	Copertura slipper: Rap
VTR232066	Center Driveshaft & Joint: Rap	Antriebswelle Mitte u. Mitnehmer: Rap	Cardan central avec noix: Rap	Trasmissione centrale & giunto: Rap

Part #   Nummer Numéro   Codice	Description	Beschreibung	Description	Descrizione
VTR235023	M3 x 6mm Cap Head Screw	M3 x 6mm Innensechskantschrauben	Vis à tête creuse M3 x 6mm	Viti a testa bombata M3 x 6mm
VTR235098	M2.5 x 8mm Button Head Screw	M2,5 x 8mm Halbrundsrauben	Vis à tête bombée M2,5 x 8mm	Viti testa tonda M2,5 x 8mm
VTR235107	M3 x 10mm Button Head Screw	M3 x 10mm Halbrundsrauben	Vis à tête bombée M3 x 10mm	Viti testa tonda M3 x 10mm
VTR235125	M4 x 20mm Button Head Screw	M4 x 20mm Halbrundsrauben	Vis à tête bombée M4 x 20mm	Viti testa tonda M4 x 20mm
VTR235320	M3 x 3mm Cup Point Set Screw	M3 x 3mm Ringschneide Gewindestift	Vis Imbus à bout cuvette M3 x 3mm	Tazza punto grani M3 x 3mm
VTR235343	M4 x 4mm Cup Point Set Screw	M4 x 4mm Ringschneide Gewindestift	Vis Imbus à bout cuvette M4 x 4mm	Tazza punto grani M4 x 4mm
VTR236015	M4 Nylock Nut	M4 Mutter Nylock	Écrou Nylock M4	Dado Nylock M4
VTR236016	M5 Nylock Nut	M5 Mutter Nylock	Écrou Nylock M5	Dado Nylock M5
VTR236076	3.2mm x 7mm x .5mm Washer	3,2mm x 7mm x ,5mm Unterlegscheiben	Rondelle 3,2mm x 7mm x ,5mm	Rondella 3,2mm x 7mm x ,5mm
VTR236138	C-Clip, 6mm	C-Clip, 6mm	C-Clip, 6mm	C-Clip, 6mm
VTR237013	6mm x 10mm x 3mm Ball Bearing	6mm x 10mm x 3mm Kugellager	Roulement 6mm x 10mm x 3mm	Cuscinetto a sfere 6mm x 10mm x 3mm
VTR237028	10mm x 15mm x 4mm Nylon Retainer Ball Bearing	Nylonkugellager gekapstelt 10 x 15 x 4mm	Roulement 10mmx 15mmx 4mm à cage nylon	Cuscinetto a sfere con fermo in nylon 10mm x 15mm x 4mm
VTR241005	Steering Rod Ends, 4.8mm: GLU	Kugelpfannen für Lenkung 4.8mm: GLU	Chapes de direction 4,8mm: GLU	Snodi sterzo, 4,8mm: GLU
VTR242003	Spur Gear, 87T: GLU	Hauptzahnrad, 87T: GLU	Couronne 87T: GLU	Corona 87T: GLU
VTR242012	Slipper Disk (2): GLU	Slipper Disk (2): GLU	Plateaux de slipper (2): GLU	Disco slipper (2): GLU
VTR242013	Slipper Pad (2): GLU	Slipper Pad (2): GLU	Garnitures de slipper (2): GLU	Slipper pad (2): GLU
VTR246002	Ball Stud, 4.8mm x 12mm (10): GLU	Kugelkopf Set, 4,8 x 12mm (10): GLU	Rotules 4.8mm x 12mm (10): GLU	Attacco a sfera, 4.8mm x 12mm (10): GLU
VTR246004	Body Clip, 6mm (10): GLU	Karosseriekammern 6mm (10): GLU	6mm clips à carrosserie (10): GLU	Clips 6mm per carrozzeria (10): GLU



# DIFFERENTIAL // DIFFERENTIAL // DIFFÉRENTIEL // DIFFERENZIALE //////////////////////////////////////

Part #   Nummer Numéro   Codice	Description	Beschreibung	Description	Descrizione
VTR232049	Complete Differential Set FR/RR	Diff Komplettsset Vorne/Hinten	Différentiel complet AV/ARR	Set differenziale completo FR/RR
VTR232054	Driveshaft (2), Fr/Rr: Hal	Antriebswelle (2) v/h: Hal	Cardan Av/arr (2): Hal	Trascinatori (2), anter/poster: Hal
VTR232056	Metal Bevel Gear & Pinion: Hal, V100	Stirnrad Metall + Ritzel: Hal, V100	Couronne et pignon coniques en métal: Hal, V100	Coppia conica in metallo & pignone: Hal, V100
VTR232057	Pin & Stopper Ring: Hal	Pin u. Stopper Ring: Hal	Goupille et anneau de retenue: Hal	Perno & anello di fermo: Hal
VTR235176	M3 x 10mm Flat Head Screw	M3 x 10mm Flachkopfschrauben	Vis à tête fraisée M3 x 10mm	Viti a testa piatta M3 x 10mm
VTR237029	12 x 18 x 4mm Ball Bearing	12 x 18 x 4mm Kugellager	Roulement 12 x 18 x 4mm	Cuscinetto a sfere 12 x 18 x 4mm

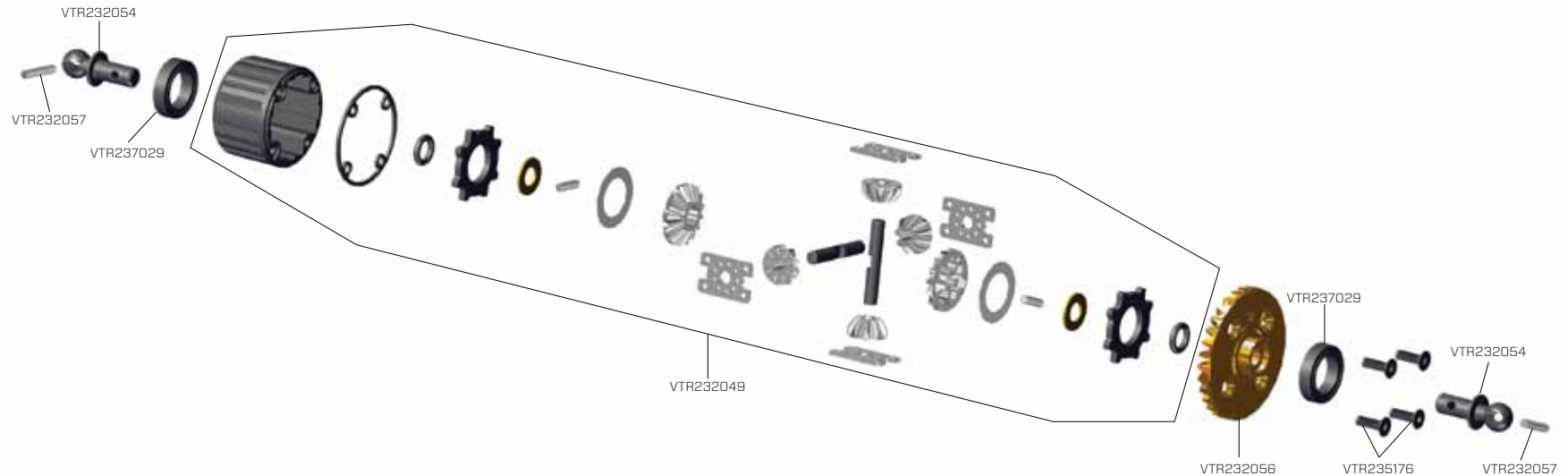

# SHOCK ASSEMBLY // STOSSDÄMPFER // ASSEMBLAGE DES AMORTISSEURS // PEZZI AMMORTIZZATORI //////////////////////////////////////

Part #   Nummer Numéro   Codice	Description	Beschreibung	Description	Descrizione
VTR233016	Shock Body & Guard, Fr/Rr: Hal	Stoßdämpfergehäuse v/h: Hal	Corps d'amortisseur Av/arr et protection: Hal	Corpo e protezione ammortizzatore, anter/ poster: Hal
VTR233017	Shock Shaft, 3 x 58.2mm (2): Hal	Stoßdämpferkolben 3 x 58,2 (2) Hal	Tige d'amortisseur 3 x 58.2mm (2): Hal	Albero ammortizzatore, 3 x 58.2mm (2): Hal
VTR233018	Springs, Fr/Rr: Hal	Federn, v/h: Hal	Ressorts Av/arr: Hal	Molle anter/poster: Hal
VTR236013	M2.5 Nylock Nut	M2,5 Muttern Nylock	Écrou Nylock M2,5	Dado Nylock M2,5
VTR236104	2.5 x 4.6 x .5mm Washer	2,5 x 4,6 x ,5mm Unterlegscheiben	Rondelle 2,5 x 4,6 x ,5mm	Rondella 2,5 x 4,6 x ,5mm
VTR243002	Shock Plastics: GLU	Dämpfer Kunststoff: GLU	Pièces plastiques d'amortisseurs: GLU	Parti in plastica ammortizzatori: GLU
VTR243003	Shock Pistons: GLU	Kolbenplatten: GLU	Pistons d'amortisseurs: GLU	Pistoni ammortizzatori: GLU
VTR243004	Shock Bottom Cap, Plastic: GLU	Dämpferkappen Oben / Kunststoff: GLU	Bouchon inférieur d'amortisseur: GLU	Tappo infer. ammortizzatore in plastica: GLU
VTR243006	Shock Cap (2): GLU	Dämpferkappen (2): GLU	Bouchon d'amortisseur (2): GLU	Tappo ammortizz. (2): GLU
VTR243008	O-Ring, Shocks (8): GLU	O-Ring / Dämpfer (8): GLU	Joints toriques d'amortisseurs (8): GLU	O-ring, ammortizz. (8): GLU
VTR243009	O-Ring, Top Cap (4): GLU	O-Ring / Dämpferkappe (4): GLU	Joints toriques de bouchons d'amortisseurs (4): GLU	O-ring, tappo super. (4): GLU
VTR243010	O-Ring, Bleeder Screw (4): GLU	O-Ring / Entlüftungsschraube (4): GLU	Joint torique de vis de purge d'amortisseurs (4): GLU	O-ring, vite spurgo (4): GLU
VTR246005	Flanged Pivot Ball, 5.8 x 3 x 7mm (10): GLU	Kugelkopf mit Flansch 5.8 x 3 x 7mm (10): GLU	Rotules épaulées 5,8 x 3 x 7mm (10): GLU	Perno sfera flangiata 5,8 x 3 x 7mm (10): GLU

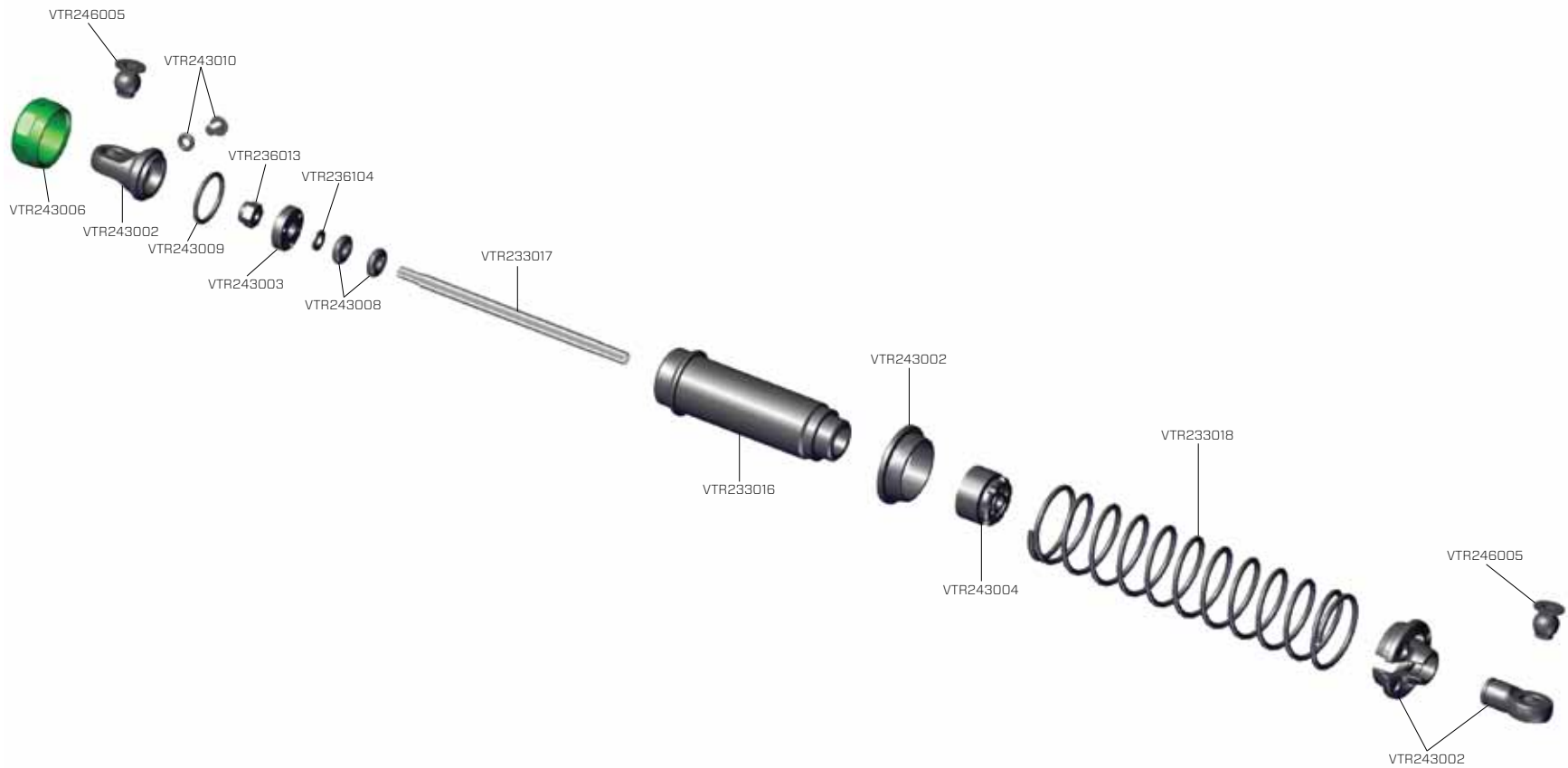

# OPTIONAL PARTS // DIVERSE TEILE // PIÈCES OPTIONNELLES // PEZZI OPZIONALI //

Part #   Nummer Numéro   Codice	Description	Beschreibung	Description	Descrizione
DYN4101	Prophet Sport Li-Po 25W AC Charger	Prophet Sport Li-Po 25W AC Ladegerät	Chargeur Prophet Sport Li-Po 25W AC	Caricatore Prophet Sport Li-Po 25W AC
DYN4105	Passport UltraForce 200W AC/DC Charger	Dynamite Passport UltraForce 200W AC/DC Lader	Chargeur Passport UltraForce 200W AC/DC	Caricatore Passport UltraForce 200W AC/DC
DYN9005EC	Reaction 7.4V 5000mAh 2S 30C Li-Po Hardcase: EC3	Dynamite Reaction 7.4V 5000mAh 2S 30C Li-Po im Hardcase: EC3	Batterie Li-Po 2S 7.4V 5000mA 30C, boîtier rigide, prise EC3	Batteria Reaction 7.4V 5000mAh 2S 30C Li-Po contenitore rigido: EC3
DYN9007EC	11.1V 5000mAh 3S 30C Li-Po Hardcase: EC3	Dynamite Reaction 11.1V 5000mAh 3S 30C Li-Po im Hardcase: EC3	Batterie Li-Po 3S 11.1V 5000mA 30C, boîtier rigide, prise EC3	Batteria 11.1V 5000mAh 3S 30C Li-Po contenitore rigido: EC3
VTR230032	Headlights/Mirrors: RAL	Spiegel: RAL	Phares/rétroviseurs : RAL	Fari/Specchi: RAL
VTR230033	Spoiler: RAL	Spoiler: RAL	Aileron : RAL	Spoiler: RAL
VTR230034	Body, Clear: RAL	Karosserie, Transparent: RAL	Carrosserie transparente: RAL	Carrozzeria trasparente: RAL
VTR230035	Body, Decorated: RAL	Karosserie gestickert: RAL	Carrosserie décorée : RAL	Carrozzeria decorata: RAL
VTR331005	Driveshaft Cover: Hal	Abdeckung Antriebswelle: Hal	Protection de cardan central : Hal	Copertura trasmissione: Hal
VTR331006	Adjustable Turnbuckle Set: Hal	Spannschraube einst.: Hal	Set de biellettes réglables : Hal	Set tenditori regolabili: Hal
VTR332011	CVA Set (2): Hal	CVA Set (2): Hal	Cardans CVA (2) : Hal	Set CVA (2): Hal
VTR333005	Front Aluminum Shock Set (2): Hal	Alu-Stoßdämpfer vorne (2): Hal	Amortisseurs avant en aluminium (2) : Hal	Set ammort. anter. alluminio (2): Hal
VTR333006	Rear Aluminum Shock Set (2): Hal	Alu-Stoßdämpfer hinten (2): Hal	Amortisseurs arrière en aluminium (2) : Hal	Set ammort. poster. alluminio (2): Hal
VTR334012	Caster Blocks, Alum: Hal	Querlenkerträgerbrücke Alu: Hal	Etriers porte fusées en aluminium : Hal	Blocchi caster allum.: Hal
VTR334013	Front Spindles, Alum: Hal	Achsschenkel Alu: Hal	Fusées avant en aluminium : Hal	Fusi anter. allum.: Hal
VTR334014	Rear Hub Carrier, Alum: Hal	Radträger hinten, Alu: Hal	Fusées arrière en aluminium : Hal	Portamozzo poster. allum.: Hal
VTR334015	Sway Bar Set: Hal	Querstabilisator Set: Hal	Jeu de barres anti-roulis: Hal	Set barra oscillante: Hal
VTR343000	Front Aluminum Shock Set (2), 95mm	Aluminium Stoßdämpferset vorne (2) 95mm	Amortisseurs avant en aluminium (2), 95mm	Set ammortizz. anter. alluminio (2), 95mm
VTR343001	Rear Aluminum Shock Set (2), 114mm	Aluminium Stoßdämpferset hinten e (2) 114mm	Amortisseurs arrière en aluminium (2), 114mm	Set ammortizz. poster. alluminio (2), 114mm



---

VATERRA®

---

It is a shared passion for motorsports and radio control. Extreme performance and extreme places. Cars and trucks that look and drive just like the real thing. Most of all, it is about gathering friends, grabbing a vehicle and having the time of your life.

---

**Adventure Driven.™**