

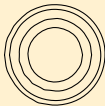

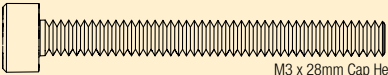

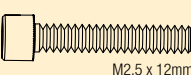

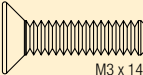

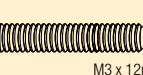
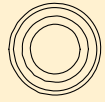
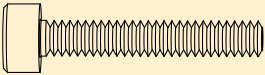
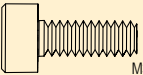
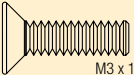

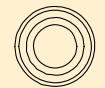
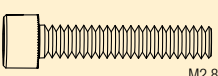
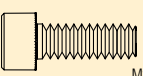
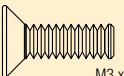

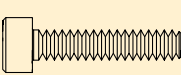
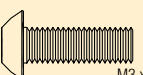

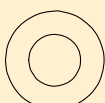
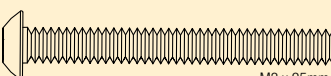
FASTENERS // VERBINDUNGSELEMENTE // ÉLÉMENTS DE FIXATION // ELEMENTI DI FISSAGGIO // //

 <p>VTR237029 x 2 12mm x 18mm x 4mm Ball Bearing 12mm x 18mm x 4mm Kugellager Roulement 12mm x 18mm x 4mm Cuscinetto a sfere 12mm x 18mm x 4mm</p>	 <p>x 10 M3 x 28mm Cap Head Screw M3 x 28mm Innensechskantschrauben Vis à tête creuse M3 x 28mm Viti a testa bombata M3 x 28mm</p>	 <p>x 10 M2,5 x 12mm Cap Head Screw M2,5 x 12mm Innensechskantschrauben Vis à tête creuse M2,5 x 12mm Viti a testa bombata M2,5 x 12mm</p>	 <p>x 10 M3 x 14mm Flat Head Screw M3 x 14mm Flachkopfschrauben Vis à tête fraisée M3 x 14mm Viti a testa piatta M3 x 14mm</p>	 <p>x 10 M3 x 12mm Cup Point Set Screw M3 x 12mm Ringschneide Gewindestift Vis Imbus à bout cuvette M3 x 12mm Tazza punto grani M3 x 12mm</p>
 <p>VTR237014 x 2 6mm x 12mm x 4mm Ball Bearing 6mm x 12mm x 4mm Kugellager Roulement 6mm x 12mm x 4mm Cuscinetto a sfere 6mm x 12mm x 4mm</p>	 <p>x 10 M3 x 18mm Cap Head Screw M3 x 18mm Innensechskantschrauben Vis à tête creuse M3 x 18mm Viti a testa bombata M3 x 18mm</p>	 <p>x 10 M3 x 8mm Cap Head Screw M3 x 8mm Innensechskantschrauben Vis à tête creuse M3 x 8mm Viti a testa bombata M3 x 8mm</p>	 <p>x 10 M3 x 12mm Flat Head Screw M3 x 12mm Flachkopfschrauben Vis à tête fraisée M3 x 12mm Viti a testa piatta M3 x 12mm</p>	 <p>x 10 M3 x 5mm Cup Point Set Screw M3 x 5mm Ringschneide Gewindestift Vis Imbus à bout cuvette M3 x 5mm Tazza punto grani M3 x 5mm</p>
 <p>VTR237009 x 2 5mm x 13mm x 4mm Ball Bearing 5mm x 13mm x 4mm Kugellager Roulement 5mm x 13mm x 4mm Cuscinetto a sfere 5mm x 13mm x 4mm</p>	 <p>x 10 M2,8 x 14mm Cap Head Screw Self Tapping M2,8 x 14mm Innensechskantschrauben selbstschneidende Vis à tête creuse auto-taraudeuses M2,8 x 14mm Viti a testa bombata autofilettanti M2,8 x 14mm</p>	 <p>x 10 M2 x 8mm Cap Head Screw M2 x 8mm Innensechskantschrauben Vis à tête creuse M2 x 8mm Viti a testa bombata M2 x 8mm</p>	 <p>x 10 M3 x 10mm Flat Head Screw M3 x 10mm Flachkopfschrauben Vis à tête fraisée M3 x 10mm Viti a testa piatta M3 x 10mm</p>	 <p>x 10 M3 x 3mm Cup Point Set Screw M3 x 3mm Ringschneide Gewindestift Vis Imbus à bout cuvette M3 x 3mm Tazza punto grani M3 x 3mm</p>
 <p>VTR237004 x 2 5mm x 10mm x 4mm Ball Bearing 5mm x 10mm x 4mm Kugellager Roulement 5mm x 10mm x 4mm Cuscinetto a sfere 5mm x 10mm x 4mm</p>	 <p>x 10 M2,8 x 10mm Cap Head Screw Self Tapping M2,8 x 10mm Innensechskantschrauben selbstschneidende Vis à tête creuse auto-taraudeuses M2,8 x 10mm Viti a testa bombata autofilettanti M2,8 x 10mm</p>	 <p>x 10 M3 x 8mm Button Head Screw M3 x 8mm Halbrundschauben Vis à tête bombée M3 x 8mm Viti testa tonda M3 x 8mm</p>	 <p>x 10 M3 x 6mm Flat Head Screw M3 x 6mm Flachkopfschrauben Vis à tête fraisée M3 x 6mm Viti a testa piatta M3 x 6mm</p>	 <p>x 10 E-Clip, 3mm E-Clip, 3mm E-Clip, 3mm E-Clip, 3mm</p>
 <p>VTR236078 x 10 4,3mm x 9mm x ,8mm Washer 4,3mm x 9mm x ,8mm Unterlegscheiben Rondelle 4,3mm x 9mm x ,8mm Rondella 4,3mm x 9mm x ,8mm</p>	 <p>x 10 M3 x 25mm Button Head Screw M3 x 25mm Halbrundschauben Vis à tête bombée M3 x 25mm Viti testa tonda M3 x 25mm</p>	 <p>x 10 M2,5 x 6mm Button Head Screw M2,5 x 6mm Halbrundschauben Vis à tête bombée M2,5 x 6mm Viti testa tonda M2,5 x 6mm</p>	 <p>x 10 M2,5 x 4mm Button Head Screw M2,5 x 4mm Halbrundschauben Vis à tête bombée M2,5 x 4mm Viti testa tonda M2,5 x 4mm</p>	 <p>x 10 C-Clip, 5mm C-Clip, 5mm C-Clip, 5mm C-Clip, 5mm</p>
 <p>VTR236076 x 10 3,2mm x 7mm x ,5mm Washer 3,2mm x 7mm x ,5mm Unterlegscheiben Rondelle 3,2mm x 7mm x ,5mm Rondella 3,2mm x 7mm x ,5mm</p>	 <p>x 10 M3 x 14mm Button Head Screw M3 x 14mm Halbrundschauben Vis à tête bombée M3 x 14mm Viti testa tonda M3 x 14mm</p>	 <p>x 10 M3 x 10mm Button Head Screw M3 x 10mm Halbrundschauben Vis à tête bombée M3 x 10mm Viti testa tonda M3 x 10mm</p>	 <p>x 10 M4 Flat Nut M4 Flachmutter Ecrou plat M4 Dado piatto M4</p>	 <p>x 10 M3 Nylock Nut M3 Muttern Nylock Ecrou Nylock M3 Dado Nylock M3</p>
 <p>VTR236104 x 10 2,5mm x 4,6mm x ,5mm Washer 2,5mm x 4,6mm x ,5mm Unterlegscheiben Rondelle 2,5mm x 4,6mm x ,5mm Rondella 2,5mm x 4,6mm x ,5mm</p>	 <p>VTR236044 x 10 M5 Nylock Flanged Serrated Nut M5 Muttern Nylock angeflanscht gezackt Ecrou Nylock bride en dents de scie M5 Dado Nylock flangiato seghettato M5</p>	 <p>VTR236043 x 10 M3 Nylock Flanged Serrated Nut M3 Muttern Nylock angeflanscht gezackt Ecrou Nylock bride en dents de scie M3 Dado Nylock flangiato seghettato M3</p>	 <p>x 10 M3 Nylock Flanged Nut M3 Muttern Nylock angeflanscht Ecrou Nylock bride M3 Dado Nylock flangiato M3</p>	 <p>x 10 M2,5 Nylock Nut M2,5 Muttern Nylock Ecrou Nylock M2,5 Dado Nylock M2,5</p>

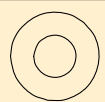
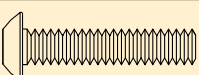
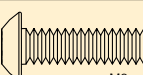
REPLACEMENT PARTS // ERSATZTEILE // PIÈCES DE RECHANGE // PEZZI DI RICAMBIO //

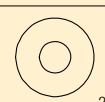
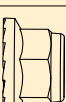
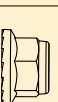
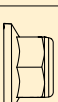
Part # Nummer Numéro Codice	Description	Beschreibung	Description	Descrizione
DYN4114	10W Li-Po AC Balance Charger	DYN4114 10W Li-Po AC Balance Ladegerät	Chargeur AC équilibrer li-Po 10W	DYN4114 10W Li-Po AC Caricatore con bilanciamento
DYN4833T	Dynamite Fuze 540 4-Pole 3300Kv Sensorless Brushless Motor	Dynamite Fuze 540 4-Pole 3300Kv Sensorloser Brushless Motor	Moteur brushless sensorless Dynamite Fuze 540 4-pôles 3300kV	Dynamite Fuze 540 4-Poli 3300Kv Motore Sensorless Brushless
DYN4850T	Dynamite Fuze 70A Waterproof Sensorless Brushless ESC	DYN4850T Dynamite Fuze 70A spritzwasserdichter Sensorloser Brushless Regler	Contrôleur brushless sensorless Dynamite Fuze 70A	DYN4850T Dynamite Fuze 70A ESC impermeabile Sensorless Brushless
DYN5204EC	Dynamite Speedpack Silver 2S 7.4V 3000mAh 20C Li-Po Battery	DYN5204EC Dynamite Speek Pack Silver 2S 7.4V 3000mAh 20C Li-Po Akku	Batterie Li-Po Dynamite Speed pack Silver 7.4V 2S 3000mA 20C	DYN5204EC Dynamite Speek Pack Silver batteria LiPo 2S 7.4V 3000mAh 20C
SPMR2400	DX2L DSM 2-Channel Surface Radio	SPMR2400 DX2L DSM 2-Kanal Surface Fernsteuerung	Radio 2 voies DX2L DSM, surface	SPMR2400 DX2L DSM radio 2 canali
SPMSR200WP	SR200WP 2-Channel DSM Waterproof Sport Receiver	SPMSR200WP SR200WP 2-Kanal DSM spritzwassergeschützter Sport Empfänger	Récepteur 2 voies étanche SR200WP DSM	SPMSR200WP SR200WP ricevitore impermeabile 2-canali DSM
SPMSS6170	S6170 Standard Digital Surface Servo	S6170 Standard Digital Surface Servo	Servo standard digital S6170	S6170 Servo digitale standard per auto
VTR240011	Flag Set	Wimpelset	Set de drapeaux	Set bandiere
VTR340002	Body Set, Clear: GLF	Karoserieset unlackiert	Carrosserie transparente	Set carrozzeria trasparente: GLF
VTR44007	Chrome Front Wheels (2): GLF, GLU	Chrom Front Räder (2) GLF, GLU	Jantes avant chromées (2)	Ruote anter. cromate (2): GLF, GLU
VTR44008	Chrome Rear Wheels (2): GLF, GLU	Chrom Heck Räder (2) GLF, GLU	Jantes arrières chromées (2)	Ruote poster. cromate (2): GLF, GLU

ASSEMBLY // MONTAGE // ASSEMBLAGE // MONTAGGIO //////////////////////////////////////

Part # Nummer Numéro Codice	Description	Beschreibung	Description	Descrizione
VTR235097	M2.5 x 6mm Button Head Screw (10)	Vaterra M2.5 x 6mm Rundkopfschraube (10)	Vis à tête bombée M2.5x6mm (10)	M2.5 x 6mm Vite a testa tonda (10)
VTR240001	Light Buckets: GL	Stoßdämpfer Endkappe: GL	Cuvelages de phares: GL	Sedi fanali: GL
VTR240010	Body Set: GLF	Vaterra GLC Karoserieset	Carrosserie	Set carrozzeria: GLF
VTR246004	Body Clip, 6mm (10)	Karoserieklammern 6mm (10):GL	6mm clips à carrosserie (10): GL	Clips 6mm per carrozzeria (10)

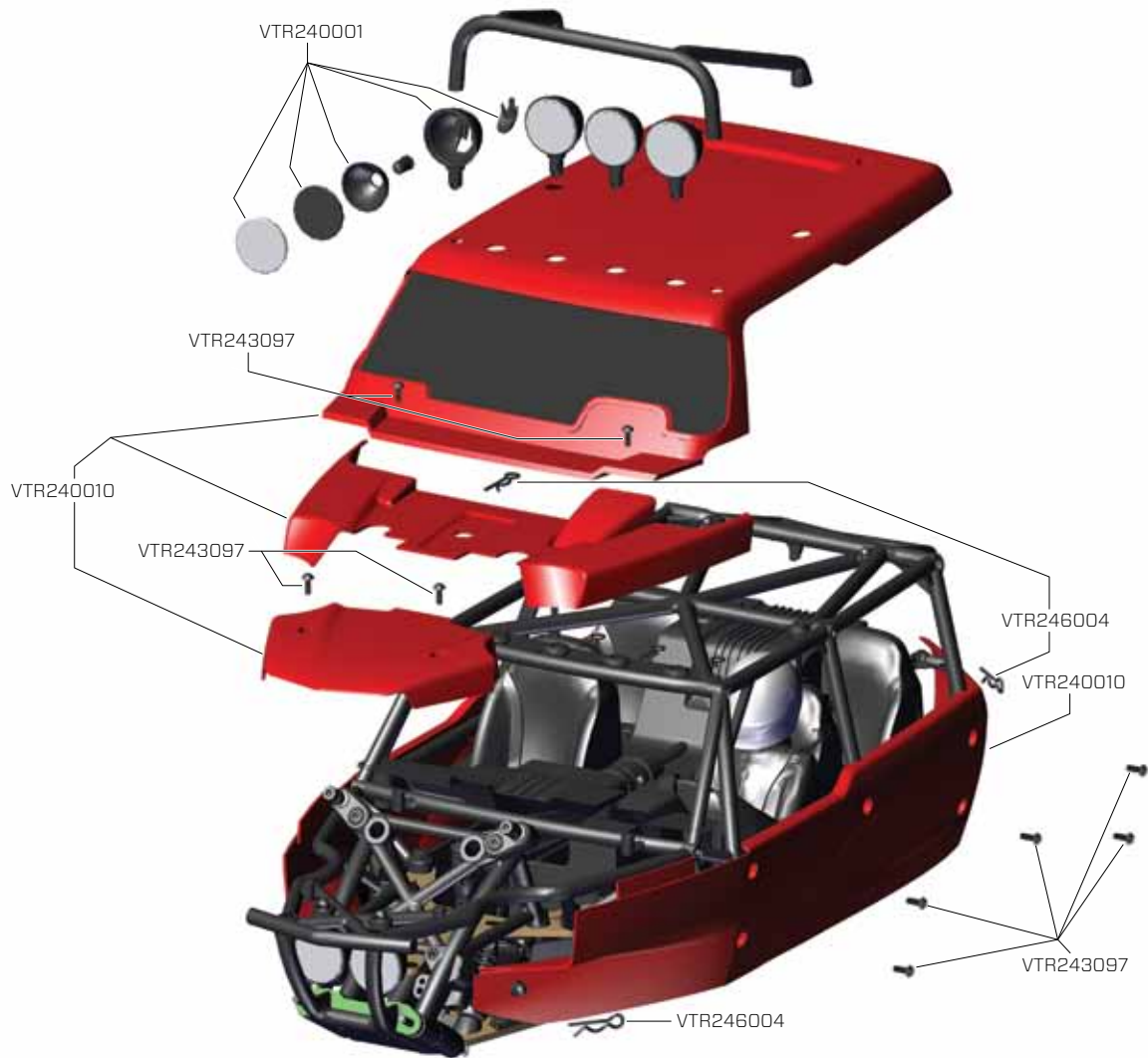

DIFFERENTIAL GEAR ASSEMBLY // DIFFERENZIAL // ASSEMBLAGE DU DIFFÉRENTIEL À PIGNONS ////////////////////////////////////// GRUPPO INGRANAGGI DIFFERENZIALE

Part # Nummer Numéro Codice	Description	Beschreibung	Description	Descrizione
VTR242000	Diff Case Halves: GL	Diffgehäuse Halb: GL	Demies coquilles de différentiel: GL	Scatola differenziale: GL
VTR242006	Differential Internals: GL	Vaterra Diff Kegelradset	Eléments internes du différentiel	Interni differenziale: GL
VTR242008	Ring Gear, 64T, 48P	Tellerrad 64T 48P	Couronne 64T, 48P: GL	Anello dentato, 64T, 48P
VTR242009	Outdrives, Diff (2)	Antriebsklauen / Diff (2)	Noix de sortie de différentiel (2): GL	Uscite differenz (2)
VTR235223	M2.8 x 14mm Cap Head Screw Self Tapping (10)	M2,8 x 14mm Innensechskantschrauben selbstschneidene (10)	Vis à tête creuse auto-taraudeuses M2,8 x 14mm (10)	Viti a testa bombata autofilettanti M2,8 x 14mm (10)
VTR237029	12 x 18 x 4mm Ball Bearing (2)	12 x 18 x 4mm Kugellager (2)	Roulement 12 x 18 x 4mm (2)	Cuscinetto a sfere 12 x 18 x 4mm (2)

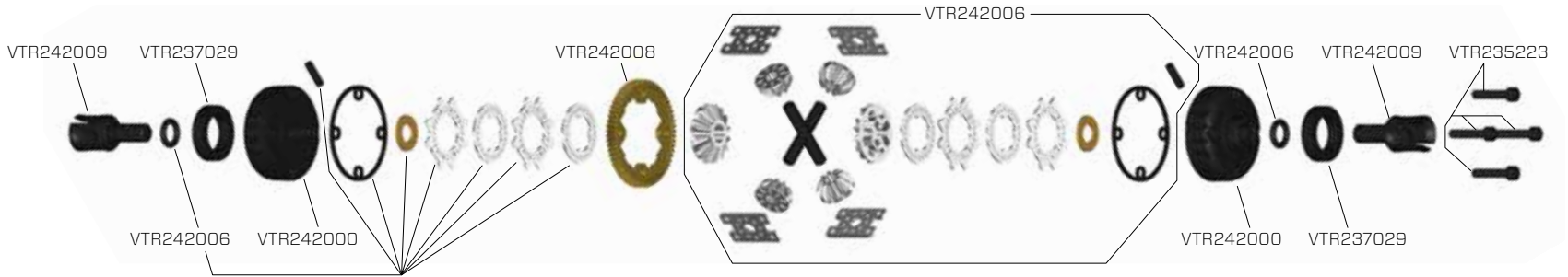

FRONT SHOCK ASSEMBLY // STOSSDÄMPFER VORNE // ASSEMBLAGE DES AMORTISSEURS AVANT //////////////////////////////////////

GRUPPO AMMORTIZZ. ANTERIORE

Part # Nummer Numéro Codice	Description	Beschreibung	Description	Descrizione
VTR235095	M2.5 x 4mm Button Head Screw (10)	M2.5 x 4mm Halbrundschrauben (10)	Vis à tête bombée M2.5 x 4mm (10)	Viti testa tonda M2.5 x 4mm (10)
VTR236013	M2.5 Nylock Nut (10)	M2,5 Muttern Nylock (10)	Ecrou auto-freiné M2,5 (10)	Dado Nylock M2,5 (10)
VTR236104	2.5 x 4.6 x .5mm Washer (10)	2,5 x 4,6 x ,5mm Unterlegscheiben	Rondelle 2,5 x 4,6 x ,5mm	Rondella 2,5 x 4,6 x ,5mm
VTR243000	Front Shock Body, Plastic: GL	Stoßdämpfergehäuse Kunststoff vorne: GL	Corps d'amortisseur avant en plastique: GL	Corpo ammortizzatore anteriore plastica: GL
VTR243002	Shock Plastics: GL	Dämpfer Kunststoff: GL	Pièces plastiques d'amortisseurs: GL	Parti in pasta ammortizzatori: GL
VTR243003	Shock Pistons: GL	Kolbenplatten: GL	Pistons d'amortisseurs: GL	Pistoni ammortizzatori: GL
VTR243004	Shock Bottom Cap, Plastic: GL	Dämpferkappen Oben / Kunststoff: GL	Bouchon inférieur d'amortisseur: GL	Tappo infer. ammortizzatore in plastica: GL
VTR243006	Shock Cap (2): GL	Dämpferkappen (2): GL	Bouchon d'amortisseur (2): GL	Tappo ammortizz. (2): GL
VTR243007	Shock Boots: GL	Staubschutzmanchetten Dämpfer: GL	Chaussettes d'amortisseurs (2): GL	Protezione ammortizz. : GL
VTR243008	O-Ring, Shocks (8)	O-Ring / Dämpfer (8)	Joints toriques d'amortisseurs (8): GL	O-ring, ammortizz. (8)
VTR243009	O-Ring, Top Cap (4)	O-Ring / Dämpferkappe (4)	Joints toriques de bouchons d'amortisseurs (4): GL	O-ring, tappo super. (4)
VTR243010	O-Ring, Bleeder Screw (4)	O-Ring / Entlüftungsschraube (4)	Joint torique de vis de purge d'amortisseurs (4): GL	O-ring, vite spurgo (4)
VTR243011	Shock Shaft, 3mm x 53mm (2)	Kolbenstange, 3mm x 53mm (2)	Tige d'amortisseurs 3x53mm (2): GL	Albero ammortizz. 3x53mm (2)
VTR243013	Spring, Front, 2.9: GL	Vaterra Federsatz Vorne 2.9	Ressorts avant dureté 2.9	Molla anteriore, 2.9: GL
VTR246005	Flanged Pivot Ball, 5.8 x 3 x 7mm (10)	Kugelkopf mit Flansch 5,8 x 3 x 7mm (10): GL	Rotules épaulées 5,8x3x7mm (10): GL	Perno sfera flangiata 5,8 x 3 x 7mm (10)

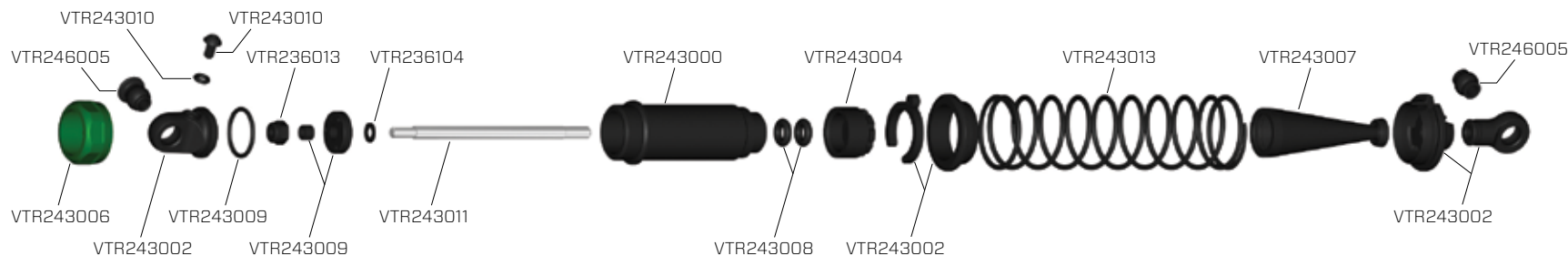

FRONT TIRE ASSEMBLY // REIFEN VORNE // MONTAGE DES PNEUS AVANT // GRUPPO GOMME ANTERIORI // // // // //

Part # Nummer Numéro Codice	Description	Beschreibung	Description	Descrizione
VTR235222	M2.8 x 10mm Cap Head Screw Self Tapping (10)	M2,8 x 10mm Innensechskantschrauben selbstschneidene	Vis à tête creuse auto-taraudeuses M2,8 x 10mm	Viti a testa bombata autofilettanti M2,8 x 10mm
VTR44000	Black Front Wheels(2): GL	Vorderer Radkranz, Schwarz: GL	Jantes AV, Noires, (2): GL	Ruota anteriore, nero: GL
VTR44002	Front Tire, Ribbed w/Foam, Med, 40mm(2): GL	Vorderreifen Ribbed Medium inkl. Einlage 40mm (2): GL	Pneus avant lignés avec insert, moyen, 40mm (2): GL	Gomma anteriore rigata, con spugna, med, 40mm (2): GL



REAR TIRE ASSEMBLY // REIFEN HINTEN // MONTAGE DES PNEUS ARRIERES // GRUPPO GOMMA POSTERIORE // // // // //

Part # Nummer Numéro Codice	Description	Beschreibung	Description	Descrizione
VTR235222	M2.8 x 10mm Cap Head Screw Self Tapping (10)	M2,8 x 10mm Innensechskantschrauben selbstschneidene (10)	Vis à tête creuse auto-taraudeuses M2,8 x 10mm (10)	Viti a testa bombata autofilettanti M2,8 x 10mm (10)
VTR44001	Black Rear Wheels(2): GL	Hinterrad, Schwarz: GL	Jantes AR, Noires, (2): GL	Ruota posteriore, nero: GL
VTR44003	Rear Tire, Tetrapod w/Foam, Med, 50mm(2): GL	Reifensatz Tetrapod Hinten Medium inkl. Einlage 50mm (2): GL	Pneus arrière Tetrapod avec insert, moyen, 50mm (2): GL	Gomma poster. Tetrapod c/spugna, med, 50mm (2): GL



Part # Nummer Numéro Codice	Description	Beschreibung	Description	Descrizione
VTR236014	M3 Nylock Nut (10)	M3 Muttern Nylock (10)	Ecrou auto-freiné M3 (10)	Dado Nylock M3 (10)
VTR236024	M3 Nylock Flanged Nut (10)	M3 Muttern Nylock angeflanscht (10)	Ecrou auto-freiné bride M3 (10)	Dado Nylock flangiato M3 (10)
VTR236044	M5 Nylock Flanged Serrated Nut (10)	M3 Muttern Nylock angeflanscht gezackt (10)	Ecrou auto-freiné épaulé rainuré M3 (10)	Dado Nylock flangiato seghettato M3 (10)
VTR236131	E-Clip, 3mm (10)	E-Clip 3mm (10)	E-Clip 3mm (10)	E-Clip 3mm (10)
VTR237004	5 x 10 x 4mm Ball Bearing (2)	5 x 10 x 4mm Kugellager (2)	Roulement 5 x 10 x 4mm (2)	Cuscinetto a sfere 5 x 10 x 4mm (2)
VTR240000	Body Mount Set, Front & Sides: GL	Gehäusebefestigungen, Front and Sides: GL	Supports de carrosserie, frontaux et latéraux: GL	Staffe Chassis, anteriori e laterali: GL
VTR240001	Light Buckets: GL	Stoßdämpfer Endkappe: GL	Cuvelages de phares: GL	Sedi fanali: GL
VTR241000	Front Tower, Supports, Covers: GL	Vorderer Dämpferdom: GL	Support d'amortisseurs avant avec protections: GL	Torre ammortizzatore anteriore: GL
VTR241001	Front Bumper: GL	Frontstoßstange: GL	Pare-choc AV: GL	Paraurti anteriore: GL
VTR241002	Rod Ends: GL	Gelenkkopf: GL	Chapes: GL	Estremità barra: GL
VTR241011	ESC Mount: GL	Montageplatte Fahrtenregler: GL	Support de contrôleur: GL	Supporto ESC: GL
VTR241014	Fr, Rr Mount Plates: GL	Stoßfänger Vorne: GL	Platines de fixation av/arr: GL	Piastre montaggio ant. post.: GL
VTR241017	Chassis, Plastic with Battery Hatch: GLF	Kunststoffchassis mit Akkufachklappe: GLF	Châssis en plastique avec trappe à batterie	Telaio in plastica con portello batteria: GLF
VTR241018	Front Bumper: GLF	Stoßfänger Vorne: GLF	Pare choc avant	Paraurti anteriore: GLF
VTR242007	Stub Axle, Front (2): GL	Radachse mit Flansch Hinten (2): GL	Axe de roue arrière en acier (2): GL	Perno ruota poster. (2): GL
VTR244000	Suspension Arm Set: GL	Querlenker Set: GL	Set de bras de suspension: GL	Set braccetti sospensioni: GL
VTR244001	Front Hub, Carrier, Hex: GL	Naben, Rad Träger, Sechskant: GL	Fusée avant, Etrier porte-fusée, hexagone: GL	Mozzi, Supporto, Dado: GL
VTR244002	Suspension Pivots, Brace: GL	Stabisatz: GL	Set d'axes et renforts de suspension: GL	Supporti braccetti sosp. : GL
VTR246001	Screw Pin, Clip Post (10)	Stiftschraube (10) :GL	Supports de clips avec goupilles (10): GL	Perni viti clip (10)
VTR246002	Ball Stud, 4.8mm x 12mm (10)	Lenkstange 4.8mm x 12mm (10)	Biellettes 4.8mm x 12mm (10)	Tenditore, 4,8mm x 12mm (10)
VTR246004	Body Clip, 6mm (10)	Karosseriekammern 6mm (10):GL	6mm clips à carrosserie (10): GL	Clips 6mm per carrozzeria (10)
VTR246006	Hinge Pin, 3mm x 29mm (2)	Hinge Pin, 3mm x 29mm (2)	Axes de suspension 3x29mm (2): GL	Perno cerniera 3x29mm (2)
VTR246007	Hinge Pin, 3mm x 51mm (2)	Hinge Pin, 3mm x 51mm (2)	Axes de suspension 3x51mm (2): GL	Perno cerniera 3x51mm (2)
VTR246009	Turnbuckle, 4-40 x 50mm (2)	Lenkstange 4-40 x 50mm (2)	Biellettes 4-40x50mm (2): GL	Tenditore, 4-40x50mm (2)

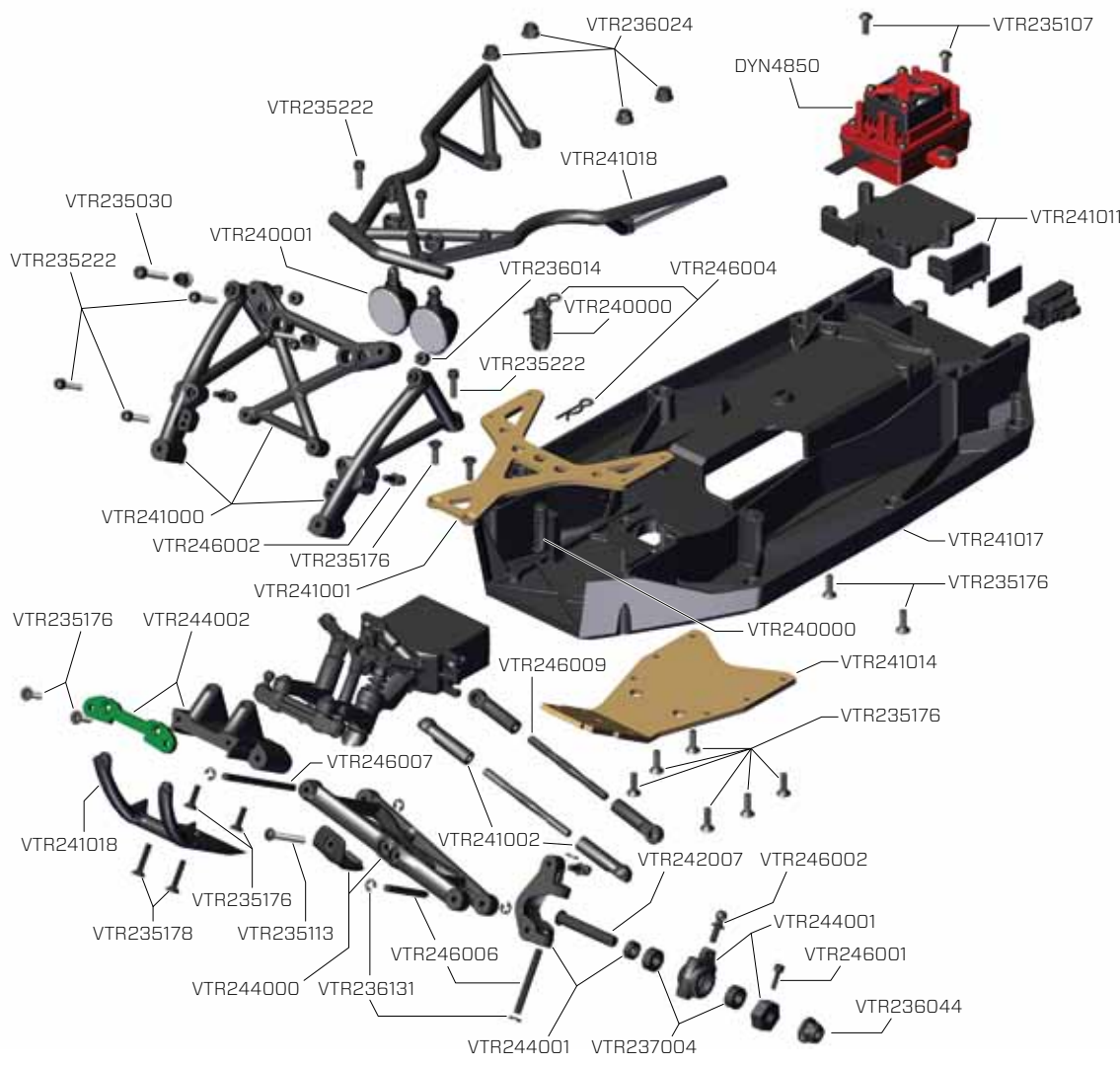

FRONT STEERING // LENKUNG // ASSEMBLAGE DE LA DIRECTION // STERZO ANTERIORE //////////////////////////////////////

Part # Nummer Numéro Codice	Description	Beschreibung	Description	Descrizione
VTR235106	M3 x 8mm Button Head Screw (10)	M3 x 8mm Halbrundschauben (10)	Vis à tête bombée M3 x 8mm (10)	Viti testa tonda M3 x 8mm (10)
VTR235109	M3 x 14mm Button Head Screw (10)	M3 x 14mm Halbrundschauben (10)	Vis à tête bombée M3 x 14mm (10)	Viti testa tonda M3 x 14mm (10)
VTR235176	M3 x 10mm Flat Head Screw (10)	M3 x 10mm Flachkopfschrauben (10)	Vis à tête fraisée M3 x 10mm (10)	Viti a testa piatta M3 x 10mm (10)
VTR235222	M2.8 x 10mm Cap Head Screw Self-Tapping (10)	M2,8 x 10mm Innensechskantschrauben selbstschneidene (10)	Vis à tête creuse auto-taraudeuses M2,8 x 10mm (10)	Viti a testa bombata autofilettanti M2,8 x 10mm (10)
VTR236014	M3 Nylock Nut (10)	M3 Muttern Nylock (10)	Ecrou auto-freiné M3 (10)	Dado Nylock M3 (10)
VTR236076	3.2mm x 7mm x .5mm Washer (10)	3,2mm x 7mm x ,5mm Unterlegscheiben (10)	Rondelle 3,2mm x 7mm x ,5mm (10)	Rondella 3,2mm x 7mm x ,5mm (10)
VTR241003	Steering Bellcranks, Horns: GL	Anlenkenset für Lenkung: GL	Renvois de direction: GL	Squadrette sterzo: GL
VTR241004	Mounts, Servo/Bellcrank: GL	Befestigung Servo/Umlenkung: GL	Supports de servos et renvois: GL	Supporti servi/squadrette: GL
VTR241005	Steering Rod Ends, 4.8mm: GL	Kugelpfannen für Lenkung 4.8mm: GL	Chapes de direction 4,8mm: GL	Snodi sterzo, 4,8mm: GL
VTR241015	Servo Saver Post, Spring: GL	Servosaver Stehbolzen / Feder: GL	Support de sauve servo avec ressort: GL	Salvaservo poster., molla: GL
VTR241019	Servo Mount, Aluminum (2): GLF	Aluminium Servobefestigung: GLF	Support de servo en aluminium (2)	Supporto servo in alluminio (2): GLF
VTR246002	Ball Stud, 4.8mm x 12mm (10)	Lenkstange 4.8mm x 12mm (10)	Bielles 4.8mm x 12mm (10)	Tenditore, 4,8mm x 12mm (10)
VTR246003	Flange Pipe, Steering Bar (2): GL	Flansch Ackermann: GL	Barre de direction, tube à brides (2): GL	Flagia tubo, barra sterzo (2): GL
VTR246010	Hinge Pin, 3mm x 34mm (2)	Hinge Pin, 3mm x 34mm (2)	Axes de suspension 3x34mm (2): GL	Perno cerniera 3x34mm (2)

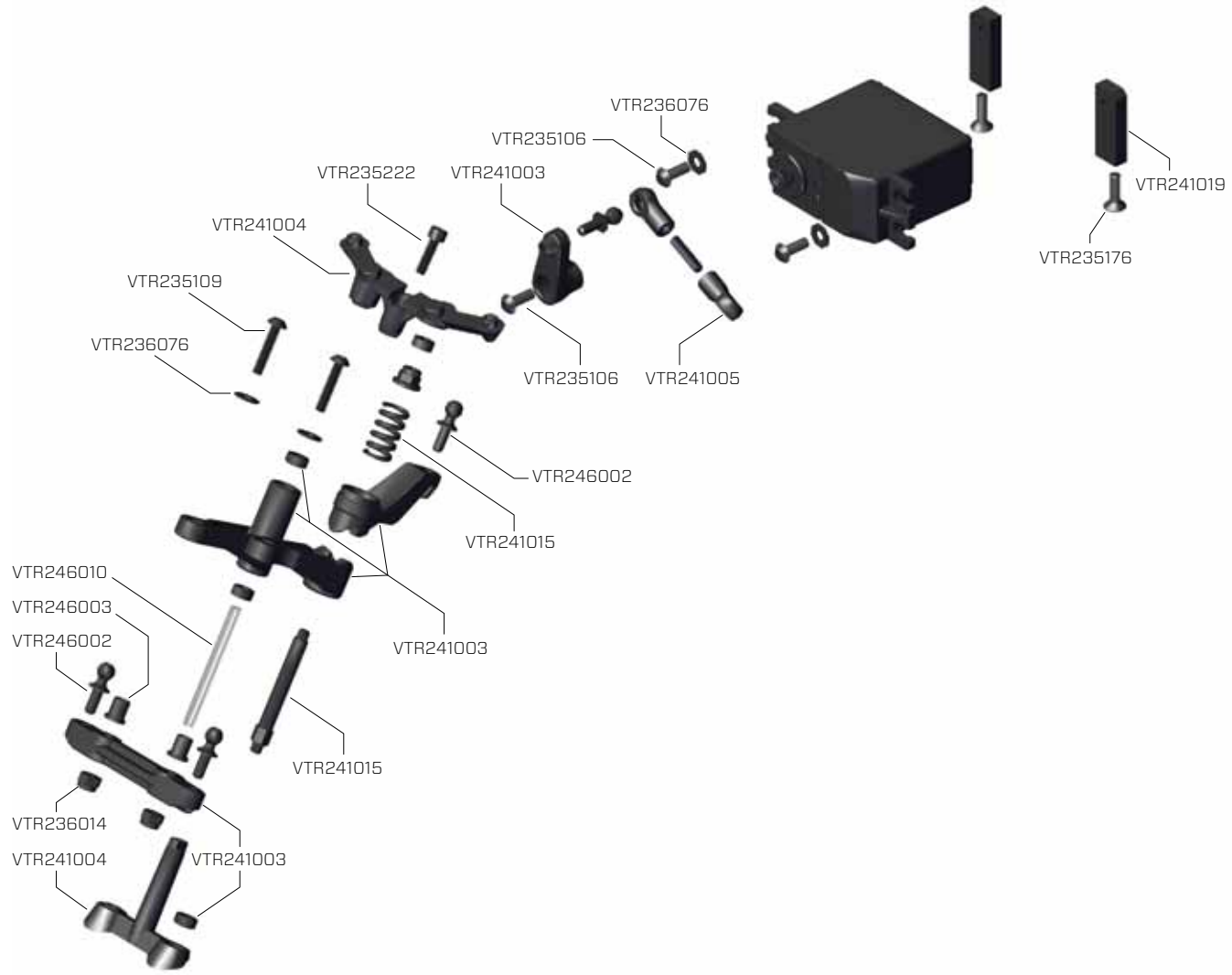

GEAR BOX // GETRIEBEGEHÄUSE // ASSEMBLAGE DE LA BOÎTE DE TRANSMISSION // SCATOLA INGRANAGGI //

Part # Nummer Numéro Codice	Description	Beschreibung	Description	Descrizione
DYN4833	Dynamite Fuze 540 4-Pole 3300Kv Sensorless Brushless Motor	Dynamite Fuze 540 4-Pole 3300Kv Sensorloser Brushless Motor	Moteur brushless sensorless Fuze 540 4-pôles 3300kV	Dynamite Fuze 540 4-Poli 3300Kv Motore Sensorless Brushless
VTR232029	Pinion Gear 20T, 48P/M3x3 Set Screw	Ritzel 20T, 48P/M3x3 Gewindestift	Pignon conique 20T, 48P/Vis Imbus M3x3	Ruota conica passo 20T, 48P/Grani M3x3
VTR232033	Pinion Gear 24T, 48P/M3x3 Set Screw	Ritzel 24T, 48P/M3x3 Gewindestift	Pignon conique 24T, 48P/Vis Imbus M3x3	Ruota conica passo 24T, 48P/Grani M3x3
VTR235025	M3 x 8mm Cap Head Screw (10)	M3 x 8mm Innensechs- kantschrauben (10)	Vis à tête creuse M3 x 8mm (10)	Viti a testa bombata M3 x8mm (10)
VTR235034	M3 x 28mm Cap Head Screw (10)	M3 x 28mm Innensechs- kantschrauben (10)	Vis à tête creuse M3 x 28mm (10)	Viti a testa bombata M3 x28mm (10)
VTR235106	M3 x 8mm Button Head Screw (10)	M3 x 8mm Halbrundschauben (10)	Vis à tête bombée M3 x 8mm (10)	Viti testa tonda M3 x 8mm (10)
VTR235222	M2.8 x 10mm Cap Head Screw Self Tapping (10)	M2,8 x 10mm Innensechs- kantschrauben selbstschneidene (10)	Vis à tête creuse auto-taraudeuses M2,8 x 10mm (10)	Viti a testa bombata autofilettanti M2,8 x 10mm (10)
VTR236076	3.2mm x 7mm x .5mm Washer (10)	3,2mm x 7mm x ,5mm Unterlegs- cheiben (10)	Rondelle 3,2mm x 7mm x ,5mm (10)	Rondella 3,2mm x 7mm x ,5mm (10)
VTR237004	5 x 10 x 4mm Ball Bearing (2)	5mm x 10mm x 4mm Kugellager (2)	Roulement 5mm x 10mm x 4mm (2)	Cuscinetto a sfere 5 x 10 x 4mm (2)
VTR237014	6 x 12 x 4mm Ball Bearing (2)	6 x 12 x 4mm Kugellager (2)	Roulement 6 x 12 x 4mm (2)	Cuscinetto a sfere 6 x 12 x 4mm (2)
VTR242001	Transmission Case Plastics: GL	Getriebegehäuse: GL	Ensemble carter de transmission: GL	Set scatola trasmissione: GL
VTR242002	Gear Cover: GL	Getriebeabdeckung GL	Carter de Réducteur: GL	Copertura per ingranaggi: GL
VTR242005	Top Shaft Assembly: GL	Stiftschraube (10): GL	Axe supérieur complet: GL	Insieme albero super.: GL
VTR242010	Motor Plate: GL	Motormontageplatte: GL	Platine moteur: GL	Piastra motore: GL
VTR242011	Middle Gear, 29T, 48P w/Snap Rings	Mittelgetriebe 29T / 48p inkl. Federring	Pignon intermédiaire 29T, 48P avec anneaux GL	Ingran. centrale, 29T, 48P c/seegeer

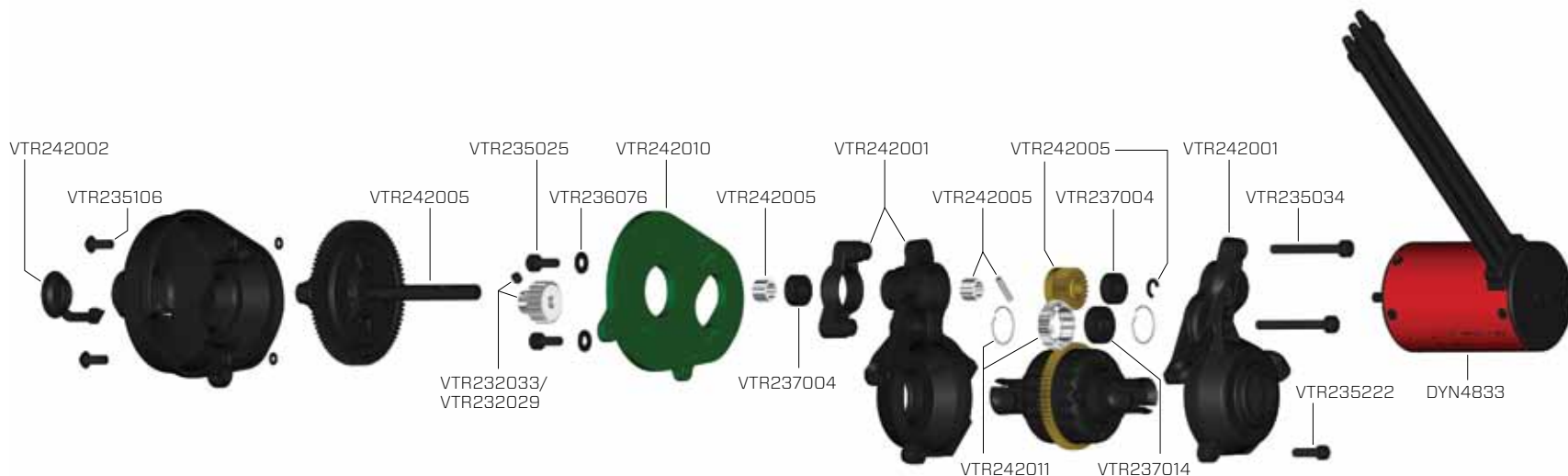

REAR CLIP // HECKCLIP // ASSEMBLAGE DU TRAIN ARRIÈRE // CLIP POSTERIORE

Part # Nummer Numéro Codice	Description	Beschreibung	Description	Descrizione
VTR235030	M3 x 18mm Cap Head Screw (10)	M3 x 18mm Innensechskantschrauben (10)	Vis à tête creuse M3 x 18mm (10)	Viti a testa bombata M3 x 18mm (10)
VTR235034	M3 x 28mm Cap Head Screw (10)	M3 x 28mm Innensechskantschrauben (10)	Vis à tête creuse M3 x 28mm (10)	Viti a testa bombata M3 x 28mm (10)
VTR235109	M3 x 14mm Button Head Screw (10)	M3 x 14mm Halbrundschrauben (10)	Vis à tête bombée M3 x 14mm (10)	Viti testa tonda M3 x 14mm (10)
VTR235113	M3 x 25mm Button Head Screw (10)	M3 x 25mm Halbrundschrauben (10)	Vis à tête bombée M3 x 25mm (10)	Viti testa tonda M3 x 25mm (10)
VTR235176	M3 x 10mm Flat Head Screw (10)	M3 x 10mm Flachkopfschrauben (10)	Vis à tête fraisée M3 x 10mm (10)	Viti a testa piatta M3 x 10mm (10)
VTR235177	M3 x 12mm Flat Head Screw (10)	M3 x 12mm Flachkopfschrauben (10)	Vis à tête fraisée M3 x 12mm (10)	Viti a testa piatta M3 x 12mm (10)
VTR235178	M3 x 14mm Flat Head Screw (10)	M3 x 14mm Flachkopfschrauben (10)	Vis à tête fraisée M3 x 14mm (10)	Viti a testa piatta M3 x 14mm (10)
VTR235222	M2,8 x 10mm Cap Head Screw Self-Tapping (10)	M2,8 x 10mm Innensechskantschrauben selbstschneidene (10)	Vis à tête creuse auto-taraudeuses M2,8 x 10mm (10)	Viti a testa bombata autofilettanti M2,8 x 10mm (10)

Part # Nummer Numéro Codice	Description	Beschreibung	Description	Descrizione
VTR236024	M3 Nylock Flanged Nut (10)	M3 Muttern Nylock angeflanscht (10)	Ecrou auto-freiné bride M3 (10)	Dado Nylock flangiato M3 (10)
VTR236131	E-Clip, 3mm (10)	E-Clip, 3mm (10)	E-Clip, 3mm (10)	E-Clip, 3mm (10)
VTR237009	5 x 13 x 4mm Ball Bearing (2)	5 x 13 x 4mm Kugellager (2)	5 x 13 x 4mm Kugellager (2)	Cuscinetto a sfere 5 x 13 x 4mm (2)
VTR240002	Main Roll Bar: GL	Vaterra Dämpferkappen Oben/ Kunststoff	Barre de protection principale: GL	Roll bar principale: GL
VTR240008	Rollbar, Top, Front: GLF	Überrollbügel, Oben, Vorne: GLF	Barre de protection supérieure avant	Rollbar, superiore, anteriore: GLF
VTR241002	Rod Ends: GL	Gelenkkopf: GL	Chapes: GL	Estremità barra: GL
VTR241006	Rear Camber Mount, Support: GL	Sturzblock hinten: GL	Axes de suspension 3x51mm (2): GL	Perno cerniera 3x51mm (2)
VTR241007	Rear Shock Tower, Roll Bar, Mounts: GL	Dämpferbrücke Hinten: GL	Support d'amortisseurs arrière avec barre de protection et supports: GL	Supporto ammortizz. poster., roll bar: GL
VTR241014	Fr, Rr Mount Plates: GL	Stoßfänger Vorne: GL	Platines de fixation av/arr: GL	Piastre montaggio ant. post.: GL
VTR242004	Rear Motor Guard, Supports: GL	Radträger Hinten (2):GL	Protection arrière de moteur: GL	Protezione motore posteriore, sup- porti: GL
VTR242016	Boot, Outdrive (4): GL	Staubschutzmanchetten / Antrieb- sklauen (4): GL	Soufflets de cardan (4): GL	Protezione perni (4): GL
VTR242017	Dogbone, Rear (2): GL	Antriebsknochen Hinten (2): GL	Cardan arrière (2): GL	Alberi trasm. posteriore (2): GL
VTR242018	Stub Axle, Rear (2): GL	Radachse mit Flansch Vorne (2): GL	Axes de roues avant en acier (2): GL	Perno ruota anter. (2): GL
VTR242019	Hex Adapter, 12mm x 6mm	Radmitnehmer 12mm x 6mm	Hexagone 12x6mm: GL	Adattatore esagonale 12x6mm
VTR244000	Suspension Arm Set: GL	Querlenker Set: GL	Set de bras de suspension: GL	Set braccetti sospensioni: GL
VTR244002	Suspension Pivots, Brace: GL	Stabisatz: GL	Set d'axes et renforts de suspen- sion: GL	Supporti braccetti sosp. : GL
VTR244003	Rear Hub(2): GL	Radträger Hinten (2): GL	Fusées arrière (2): GL	Mozzo posteriore (2): GL
VTR246000	Body Clips, Mini (10)	Karosseriekammern Mini (10): GL	Mini clips à carrosserie (10): GL	Clips mini per carrozzeria (10)
VTR246001	Screw Pin, Clip Post (10)	Stiftschraube (10) :GL	Supports de clips avec goupilles (10): GL	Perni viti clip (10)
VTR246002	Ball Stud, 4.8mm x 12mm (10)	Lenkstange 4.8mm x 12mm (10)	Biellettes 4.8mm x 12mm (10)	Tenditore, 4,8mm x 12mm (10)
VTR246007	Hinge Pin, 3mm x 51mm (2)	Hinge Pin, 3mm x 51mm (2)	Axes de suspension 3x51mm (2): GL	Perno cerniera 3x51mm (2)
VTR246009	Turnbuckle, 4-40 x 50mm (2)	Lenkstange 4-40 x 50mm (2)	Biellettes 4-40x50mm (2): GL	Tenditore, 4-40x50mm (2)
VTR246010	Hinge Pin, 3mm x 34mm (2)	Hinge Pin, 3mm x 34mm (2)	Axes de suspension 3x34mm (2): GL	Perno cerniera 3x34mm (2)

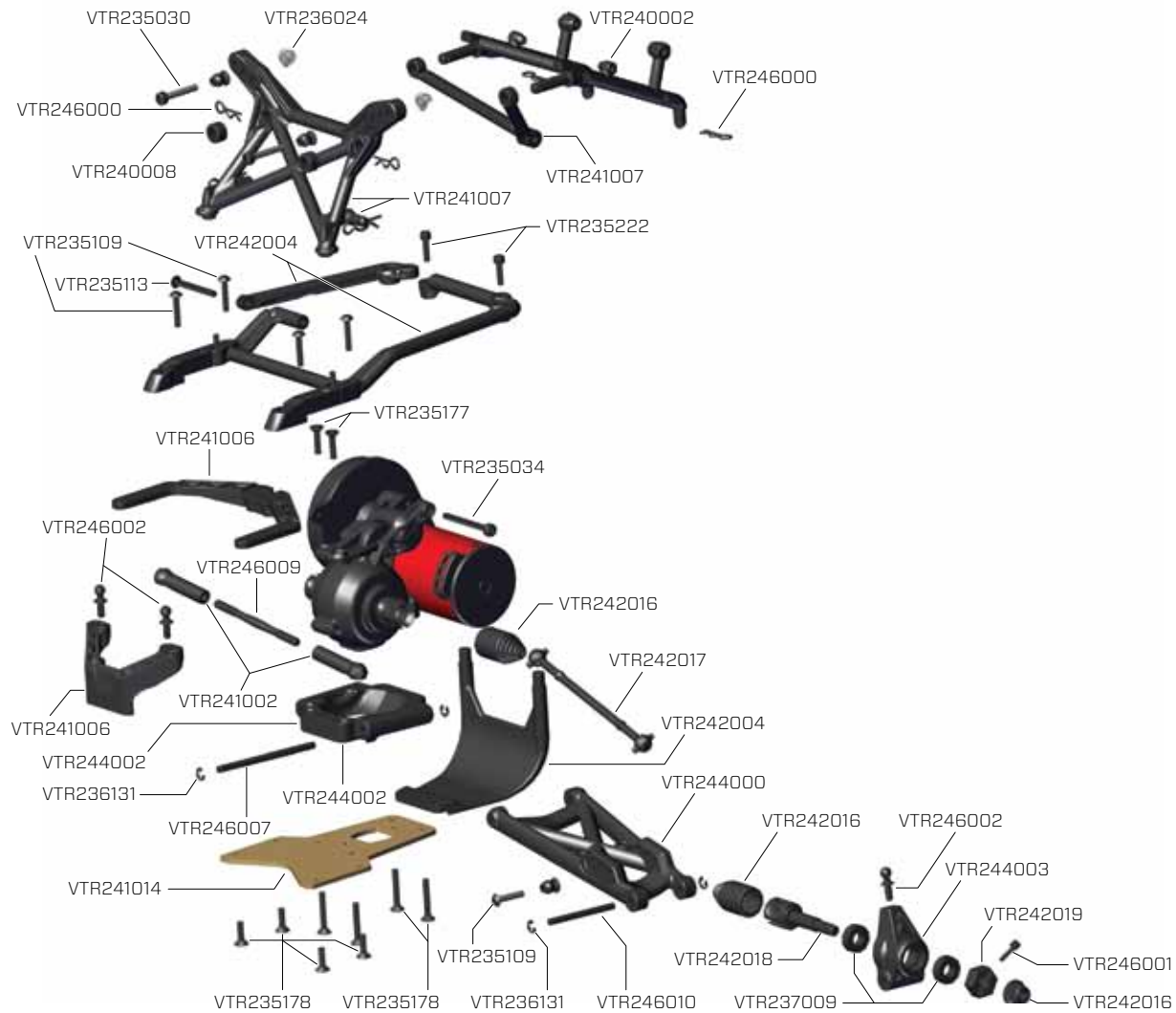

REAR SHOCK ASSEMBLY // STOSSDÄMPFER HINTEN // ASSEMBLAGE DES AMORTISSEURS ARRIÈRE //////////////////////////////////////

GRUPPO AMMORTIZZ. POSTERIORE

Part # Nummer Numéro Codice	Description	Beschreibung	Description	Descrizione
VTR235095	M2.5 x 4mm Button Head Screw (10)	M2.5 x 4mm Halbrundschauben (10)	Vis à tête bombée M2.5 x 4mm (10)	Viti testa tonda M2.5 x 4mm (10)
VTR236013	M2.5 Nylock Nut (10)	M2,5 Muttern Nylock (10)	Ecrou auto-freiné M2,5 (10)	Dado Nylock M2,5 (10)
VTR236104	2.5 x 4.6 x .5mm Washer (10)	2,5 x 4,6 x ,5mm Unterlegscheiben	Rondelle 2,5 x 4,6 x ,5mm	Rondella 2,5 x 4,6 x ,5mm
VTR243001	Rear Shock Body, Plastic: GL	Stoßdämpfergehäuse Kunststoff hinten: GL	Corps d'amortisseur arrière en plastique: GL	Corpo ammortizzatore posteriore plastica: GL
VTR243002	Shock Plastics: GL	Dämpfer Kunststoff: GL	Pièces plastiques d'amortisseurs: GL	Parti in plastica ammortizzatori: GL
VTR243003	Shock Pistons: GL	Kolbenplatten: GL	Pistons d'amortisseurs: GL	Pistoni ammortizzatori: GL
VTR243004	Shock Bottom Cap, Plastic: GL	Dämpferkappen Oben / Kunststoff: GL	Bouchon inférieur d'amortisseur: GL	Tappo infer. ammortizzatore in plastica: GL
VTR243006	Shock Cap (2): GL	Dämpferkappen (2): GL	Bouchon d'amortisseur (2): GL	Tappo ammortizz. (2): GL
VTR243007	Shock Boots: GL	Staubschutzmanchetten Dämpfer: GL	Chaussettes d'amortisseurs (2): GL	Protezione ammortizz. : GL
VTR243008	O-Ring, Shocks (8)	O-Ring / Dämpfer (8)	Joints toriques d'amortisseurs (8): GL	O-ring, ammortizz. (8)
VTR243009	O-Ring, Top Cap (4)	O-Ring / Dämpferkappe (4)	Joints toriques de bouchons d'amortisseurs (4): GL	O-ring, tappo super. (4)
VTR243010	O-Ring, Bleeder Screw (4)	O-Ring / Entlüftungsschraube (4)	Joint torique de vis de purge d'amortisseurs (4): GL	O-ring, vite spurgo (4)
VTR243012	Shock Shaft, 3mm x 63mm (2)	Kolbenstange, 3mm x 63mm (2)	Tige d'amortisseurs 3x63mm (2): GL	Albero ammortizz. 3x63mm (2)
VTR243014	Spring, Rear, 1.9: GL	Federsatz Hinten 1.9: GL	Ressorts arrière, dureté 1,9: GL	Molla poster. 1,9: GL
VTR246005	Flanged Pivot Ball, 5.8 x 3 x 7mm (10)	Kugelkopf mit Flansch 5.8 x 3 x 7mm (10): GL	Rotules épaulées 5,8x3x7mm (10): GL	Perno sfera flangiata 5,8x3x7mm (10)

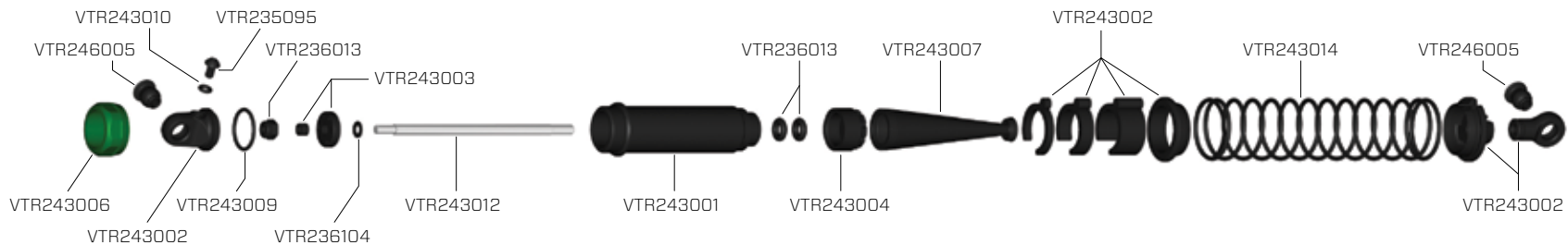

RECEIVER BOX // EMPFÄNGERBOX // ASSEMBLAGE DU COMPARTIMENT RADIO // SCATOLA RICEVITORE //

Part # Nummer Numéro Codice	Description	Beschreibung	Description	Descrizione
SPMSR200WP	SR200WP 2-Channel DSM Waterproof Sport Receiver	SPMSR200WP SR200WP 2-Kanal DSM spritwassergeschützter Sport Empfänger	Récepteur 2 voies étanche SR200WP DSM	SPMSR200WP SR200WP ricevi- tore impermeabile 2-canali DSM
VTR235222	M2,8 x 10mm Cap Head Screw Self Tapping (10)	M2,8 x 10mm Innensechs- kantschrauben selbstschneidene (10)	Vis à tête creuse auto-taraudeuses M2,8 x 10mm (10)	Viti a testa bombata autofilettanti M2,8 x 10mm (10)
VTR235322	M3 x 5mm Cup Point Set Screw (10)	M3 x 5mm Ringschneide Gewindestift (10)	Vis Imbus à bout cuvette M3 x 5mm (10)	Tazza punto grani M3 x 5mm (10)
VTR241010	Receiver Box: GL	Empfängerbox: GL	Boîtier radio: GL	Scatola ricevitore: GL
VTR241012	Cap, Antenna (5)	Antennenkappe (5): GL	Capuchon d'antenne (5): GL	Tappo antenna (5)
VTR241016	Receiver Box Seals: GL	Empfängerboxdichtung	Joints de compartiment radio: GL	Guarnizioni scatola radio: GL

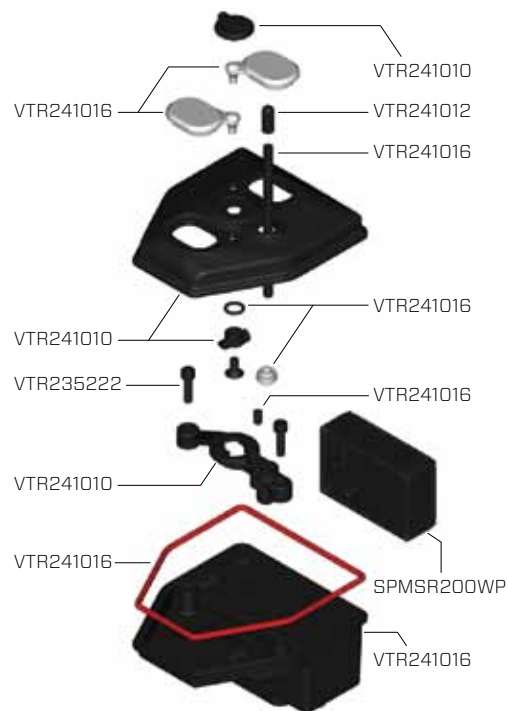

ROLLBAR ASSEMBLY // ÜBERROLLBÜGEL // ASSEMBLAGE DE L'ARCEAU // GRUPPO ROLLBAR //////////////////////////////////////

Part # Nummer Numéro Codice	Description	Beschreibung	Description	Descrizione
VTR235222	M2,8 x 10mm Cap Head Screw Self-Tapping (10)	M2,8 x 10mm Innensechskantschrauben selbstschneidene (10)	Vis à tête creuse auto-taraudeuses M2,8 x 10mm (10)	Viti a testa bombata autofilettanti M2,8 x 10mm (10)
VTR235223	M2,8 x 14mm Cap Head Screw Self-Tapping (10)	M2,8 x 14mm Innensechskantschrauben selbstschneidene (10)	Vis à tête creuse auto-taraudeuses M2,8 x 14mm (10)	Viti a testa bombata autofilettanti M2,8 x 14mm (10)
VTR240001	Light Buckets: GL	Stoßdämpfer Endkappe: GL	Cuvelages de phares: GL	Sedi fanali: GL
VTR240007	Rollbar, Sides: GLF	Vaterra GLC Seitenteil, Überrollkäfig GLF	Barres de protection latérales	Rollbar, Laterale: GLF
VTR240008	Rollbar, Top, Front: GLF	Dach und Vorderteil, Überrollkäfig: GLF	Barre de protection supérieure avant	Rollbar, superiore, anteriore: GLF
VTR240010	Body Set: GLF	Karoserieset GLF	Carrosserie	Set carrozzeria: GLF
VTR241017	Chassis, Plastic with Battery Hatch: GLF	Kunststoffchassis mit Akkufachklappe GLF	Châssis en plastique avec trappe à batterie	Telaio in plastica con portello batteria: GLF
VTR246000	Body Clips, Mini (10)	Karosserieklammern Mini (10): GL	Mini clips à carrosserie (10): GL	Clips mini per carrozzeria (10)



WING ASSEMBLY // FLÜGEL // ASSEMBLAGE DE L'AILERON // GRUPPO ALETTONE //////////////////////////////////////

Part # Nummer Numéro Codice	Description	Beschreibung	Description	Descrizione
VTR235222	M2.8 x 10mm Cap Head Screw Self Tapping (10)	M2,8 x 10mm Innensechskantschrauben selbstschneidene (10)	Vis à tête creuse auto-taraudeuses M2,8 x 10mm (10)	Viti a testa bombata autofilettanti M2,8 x 10mm (10)
VTR240002	Main Roll Bar: GL	Überrollkäfig: GL	Barre de protection principale: GL	Roll bar principale:GL
VTR240003	Wing Mounts: GL	Spoilerbefestigung	Supports d'aileron: GL	Supporti alettone: GL
VTR240004	Wing Set: GL	Kotflügelsatz: GL	Set d'ailerons: GL	Set alettone: GL
VTR246000	Body Clips, Mini (10)	Karosserieklammern Mini (10):GL	Mini clips à carrosserie (10): GL	Clips mini per carrozzeria (10)



OPTIONAL PARTS // OPTIONALE BAUTEILE // PIÈCES OPTIONNELLES // PEZZI OPZIONALI //////////////////////////////////////

Part # Nummer Numéro Codice	Description	Beschreibung	Description	Descrizione
DYN9005EC	Reaction 7.4V 5000mAh 2S 30C Li-Po Hard Case: EC3	Dynamite Reaction 7.4V 5000mAh 2S 30C Li-Po im Hardcase: EC3	Batterie Li-Po Reaction 2S 7.4V 5000mA 30C, boîtier rigide, prise EC3	Reaction 7.4V 5000mAh 2S 30C Li-Po Custodia rigida: EC3
DYN9007EC	Reaction 11.1V 5000mAh 3S 30C Li-Po Hard Case: EC3	Dynamite Reaction 11.1V 5000mAh 3S 30C Li-Po im Hardcase: EC3	Batterie Li-Po Reaction 3S 11.1V 5000mA 30C, boîtier rigide, prise EC3	Reaction 11.1V 5000mAh 3S 30C Li-Po Custodia rigida: EC3
DYNP4000EC	Speedpack Platinum 7.4V 5200mAh 2S 50C Li-Po Case: EC3	Dynamite Speedpk Platinum 7.4V 5200mAh 2S 50C Li-Po im Gehäuse : EC3	Batterie Li-Po Speedpack Platinum 2S 7.4V 5200mA 50C, boîtier rigide, prise EC3	Speedpack Platinum 7.4V 5200mAh 2S 50C Li-Po Custodia: EC3
DYNP4001EC	Speedpack Platinum 11.1V 5200mAh 3S 50C Li-Po Case: EC3	Dynamite Speedpk Platinum 11.1V 5200mAh 3S 50C Li-Po im Gehäuse : EC3	Batterie Li-Po Speedpack Platinum 3S 11.1V 5200mA 50C, boîtier rigide, prise EC3	Speedpack Platinum 11.1V 5200mAh 3S 50C Li-Po Custodia: EC3
VTR340003	Light Set w/Buckets: GLF	Lichtset m. Halter. GLF	Kit éclairage	Set fanali: GLF
VTR340004	Chrome Roll Cage: GLF	Chrom Überrollkäfig :GLF	Arceau chromé	Gabbia di protezione, cromata: GLF
VTR343000	Front Aluminum Shock Set (2), 95mm	Aluminium Stoßdämpferset vorne (2) 95mm	Amortisseurs avant en aluminium (2), 95mm	Set ammortizz. anter. alluminio (2), 95mm
VTR343001	Rear Aluminum Shock Set (2), 114mm	Aluminium Stoßdämpferset hinten (2) 114mm	Amortisseurs arrière en aluminium (2), 114mm	Set ammortizz. poster. alluminio (2), 114mm
VTR344000	Sway Bar Set	Querstabilisator Set	Jeu de barres anti-roulis	Set barra oscillante
VTR44004	Rear Tire, Paddle w/Foam, 50mm (2)	Vaterra Hinterreifen Paddle mit Schaum, 50mm (2)	Pneux arrière à pelles avert inserts, 50mm (2)	Gomma posteriore c/spugna, 50mm (2)
VTR44005	Front Tire, Ribbed w/Foam, Soft, 40mm(2)	Reifen vorne m. Schaumeinlage, oft 40mm (2)	Pneus avant lignés avec insert, souple, 40mm (2)	Gomma anter., ribbed c/espanso, morbida, 40mm(2)
VTR44006	Rear Tire,Tetrapod w/Foam, Soft, 50mm (2)	Reifen hinten m. Schaumeinlage Soft 50mm (2)	Pneus arrière Tetrapod avec insert, souple, 50mm (2)	Gomma anter., tetrapod c/espanso, morbida, 50mm(2)



VATERRA™

It is a shared passion for motorsports and radio control. Extreme performance and extreme places. Cars and trucks that look and drive just like the real thing. Most of all, it is about gathering friends, grabbing a vehicle and having the time of your life.

Adventure Driven.™